New generation of intelligent pattern control system

Operating instructions

Foreword

Welcome to use our special sewing machine control system.

Please read this operating manual carefully to ensure proper operation and use of special sewing machines, Please follow the instructions in this manual. Otherwise, the company will not be liable for any losses caused by illegal operation.





In addition, keep this user manual in a safe place for easy access.

In the event of failure, repairs must be performed by a technician or professional designated by the company.







Safety Precautions





1. Signs and meanings of safe operation

















The safety signs used in this instruction manual and the product are designed to allow you to use the product correctly and safely to prevent injury to you and others. The pattern and meaning of the logo are as follows:

 危险	If you ignore this mark and perform the wrong operation, it may result in serious injury or death.
 注意	If you ignore this mark and perform the wrong operation, it may result in personal injury and equipment damage.
	This symbol indicates "should be noted". The pattern in the triangle indicates what must be noted. (For example, the pattern on the left indicates: "Beware of injury")
	This symbol means "prohibited"
	This symbol indicates "must". The pattern in the circle indicates what must be done. (For example, the pattern on the left indicates "must be grounded")

2. Safety precautions

 危险	
	When opening the control box, turn off the power switch and unplug the power plug from the outlet. Wait at least 5 minutes before opening the control box cover. Touching an area with a high voltage can cause personal injury.
 注意	
Using environment	
	Avoid using the sewing machine near strong electrical interference sources such as high frequency welders. Strong electrical interference sources may affect the normal operation of the sewing machine.
	The fluctuation of the power supply voltage should be used within $\pm 20\%$ of the rated voltage. Large fluctuations in voltage can affect the normal operation of the sewing machine and require a voltage regulator.
	The ambient temperature should be used in the range of $5^{\circ}\text{C}\sim 35^{\circ}\text{C}$. Low temperatures or high temperatures can affect the normal operation of the sewing machine.

	The relative humidity should be in the range of 45% to 85%, and the device should not be used in the environment where condensation does not form. Dry, wet or dew condensation can affect the proper operation of the sewing machine.
	The compressed air supply should be greater than the total gas consumption required by the sewing machine. The insufficient supply of compressed air will lead to abnormal operation of the sewing machine.
	In case of lightning storm, turn off the power switch and unplug the power plug from the socket. Lightning may affect the correct operation of sewing machines.
install	
	Please let the trained technician install the sewing machine.
	Please do not connect to the power supply until the installation is complete. If you press the start switch by mistake, the sewing machine will cause injury.

	<p>When the sewing machine head falls or rises, please operate with both hands. Don't press the sewing machine hard.</p> <p>If the sewing machine is out of balance, the slippage of the sewing machine to the ground will cause injury or damage to the machine.</p>
	<p>It must be ground.</p> <p>The ground wire is not firm, which is the cause of electric shock or wrong action.</p>
	<p>All cables should be fixed at least outside the 25mm of the movable parts. In addition, do not bend too much or fasten it too tightly with pins. The risk of fire or electric shock.</p>
	<p>Please install the safety case on the machine head.</p>
sewing	
	<p>This sewing machine is limited to personnel trained in safe operation.</p>
	<p>This sewing machine cannot be used for any purpose other than sewing.</p>
	<p>Protective glasses must be worn when using sewing machines.</p> <p>If you do not wear protective glasses, the broken part of the needle may pop into the eye and cause injury when the needle is broken.</p>
	<p>Please cut off the power supply immediately when the following conditions occur. Otherwise, when the switch is pressed by mistake, it will cause injury.</p> <p>1. When the needle is pierced, 2. When changing the needle, 3. When the sewing machine is not in use or when a person leaves the sewing machine</p>
	<p>Do not touch any moving parts or lean them against them during sewing, as this can cause injury or damage to the sewing machine.</p>
	<p>If there is a mistake in the operation of the sewing machine, or if you hear abnormal noise or smell abnormal smell, you should immediately turn off the power supply. Then contact the purchase store or trained technician.</p>
	<p>If the sewing machine fails, please contact the purchasing store or trained technician.</p>
Maintenance and inspection	
	<p>Only trained technicians can repair, maintain and inspect sewing machines.</p>
	<p>Please contact the professionals of electronic control manufacturer in time for electrical repair, maintenance and inspection.</p>
	<p>Turn off the power and unplug the power when the following occurs. Otherwise, when the switch is pressed by mistake, it will cause injury.</p> <p>1. Inspection, adjustment and maintenance 2. Replacement of vulnerable parts such as needles, cutters, etc.</p>
	<p>Before checking, adjusting, and repairing any pneumatic equipment, please disconnect the gas source and wait for the gauge pointer to drop to "0".</p>
	<p>Be careful to follow all safety considerations when you have to connect the power switch and the gas source switch to adjust.</p>



Damage to sewing machine caused by unauthorized modification of sewing machine is not covered by warranty.

Catalogue

1 Summary description.....	1
1.1 summary.....	1
1.2 Technical parameter table.....	1
1.3 List of sewing patterns(430F).....	2
1.4 List of sewing patterns(438F).....	8
1.5 Sewing pattern list (0806).....	11
1.6 Matters needing attention in safe use.....	16
1.7 Precautions for use.....	19
1.8 Standardization.....	21
1.9 Mode of operation.....	21
2 Instructions.....	22
2.1 Universal button.....	22
2.2 Basic operation.....	23
2.3 Ordinary pattern operation.....	24
2.4 Pattern registration.....	26
2.5 Pattern naming.....	27
2.6 Winding.....	28
2.7 Threading.....	29
2.8 Pattern selection.....	30
2.9 Sewing data setting.....	32
2.10 P pattern registration.....	34
2.11 Trial operation.....	36
2.12 Counter operation.....	37
2.13 Adjust the stitching point operation.....	40
2.14 Emergency stop.....	40
3 Fast (P) pattern operation.....	41
3.1 P pattern data input.....	41
3.2 P Pattern Editing.....	43
3.3 P Pattern paste.....	44
3.4 P Pattern sewing.....	45
4 Combination (C) pattern operation.....	47
4.1 C Pattern data input.....	47
4.2 C pattern editing.....	49
4.3 C pattern selection.....	51
4.4 C pattern sewing.....	52
5 Pattern editing.....	54
5.1 Enter the pattern editing mode.....	54
5.2 Pattern Edition.....	58
5.3 Pattern modification.....	62
5.4 Exit pattern editing mode.....	65
6 Information function.....	66

6.1 View version information.....	66
7 Communication function.....	67
7.1 About data that can be processed.....	67
7.2 Pattern transmission.....	67
8 Mode and parameter settings.....	72
8.1 Mode switching.....	72
8.2 Test.....	73
8.3 parameter settings.....	77
8.4 Accessibility.....	87
8.5 counter.....	89
8.6 Regarding.....	89
9. Appendix 1 Error Table.....	90

1 Summary description

1.1 summary

This series of industrial sewing machine computer control system, spindle motor with the world advanced level of AC servo control technology to drive, with the characteristics of large torque, high efficiency, stable speed and low noise. The diversified design of the operation panel can meet the matching requirements of different customers; the system adopts German structure design, the installation and maintenance are convenient and fast, and the system control software can be upgraded through remote communication to facilitate users to continuously improve the performance of the product.

1.2 Technical parameter table

	430F Direct driving computer flat seam knotting machine	438F Direct driving computer flat seam nail fastening machine
Trace form	Single needle flat seam	
Maximum sewing speed	3,200 sti/min	2,700 sti/min
Size(X×Y)	maximum 40×30 mm	maximum 6.4×6.4 mm
Size of sewing button		Button outer diameter 8~30mm(※1)
Delivery drive mode	Y-θ Intermittent feeding (pulse motor drive)	
Needle gage	0.05~12.7mm	0.05~6.4mm
Number of needles	Please refer to the Sewing pattern list for the number of sewing stitches you have entered.	
Maximum number of needles	About 5000 needles (pattern 1)	
Lifting foot drive mode	Pulse motor drive	
Pressure foot lift button clip rise amount	maximum 17mm	maximum 13mm
Shuttle hook used	Standard semi-rotating shuttle (double spinning shuttle sold separately)	Standard semi-rotating shuttle
Digital tensioner	standard facility	
Wire sweeper	standard facility	
Tangent device	standard facility	
Trapper	Specifications: options	option
Data storage mode	Quick erase memory (any sewing pattern can be added to the U disk)	
Data carrier	U disk (≤ 2)	
Number of cyclic programs	Up to 30 registrations (up to 50 steps per step)	

Number of stored data	89 sewing patterns have been set	64 sewing patterns have been set
	(up to 799 additional sewing pattern types. The total number of additional needles is 500000.) (≤ 3)	
Motor	AC servo motor 550W	
Weight	Head: about 57 kg, operating panel: about 0.4kg control box: 9kg	
Power	Single phase 220 V, 3 phase 380 V (for three phase 380 V, need to use transformer.)2502B 2278 B	

※ 1When the outer diameter is above 20mm, please use the optional button clip assembly B (S03634 / 101)。

※ 2 There is no guarantee of operational problems caused by the use of any media。













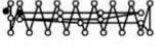



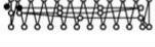

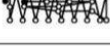

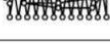
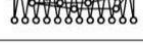
※ 3 The number and number of stitches that can be recorded will depend on the number of needles per sewing pattern. ◦

1.3List of sewing patterns(430F).

The sewing patterns shown below are pre-set and can be selected according to the specifications. (As long as it can be confirmed that it is within the working range of the presser foot and the feed plate, you can choose to use any sewing pattern.)

Use a presser foot and a feed plate that meet the requirements of various sewing patterns.



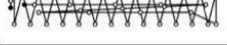
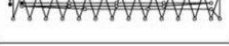
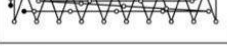





The length of sewing when the size is 100% scaling.

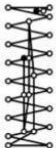

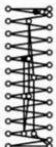

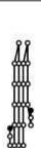
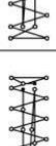
适用于一般重量的布料 (-03)									
号码	花样	针数	尺寸 (mm)		号码	花样	针数	尺寸 (mm)	
			长度	宽度				长度	宽度
1		42	16	2	65		43	16	2
4		31	16	2	66		32	16	2
5		29	10	2	67		30	10	2
8		21	7	2	68		22	7	2
13		35	10	2	69		36	10	2
15		42	10	2	70		43	10	2
20		28	7	2	71		29	7	2
21		35	7	2	72		36	7	2
64		30	16	2	89		90	24	3
适用于厚重的布料 (-05)									
号码	花样	针数	尺寸 (mm)		号码	花样	针数	尺寸 (mm)	
			长度	宽度				长度	宽度
2		42	20	3	18		56	24	3
3		35	20	3	19		64	24	3
6		30	16	3	62		42	20	3
14		35	16	3	63		35	20	3
16		43	16	3	78		43	20	3
17		42	24	3	79		36	20	3
适用于厚重的布料 (-05)									

号码	花样	针数	尺寸 (mm)		号码	花样	针数	尺寸 (mm)	
			长度	宽度				长度	宽度
80		31	16	3	83		43	24	3
81		36	16	3	84		57	24	3
82		44	16	3	85		65	24	3
适用于针织布料 (-OK) 和女性内衣 (-OF)									
号码	花样	针数	尺寸 (mm)		号码	花样	针数	尺寸 (mm)	
			长度	宽度				长度	宽度
7		28	8	2	73		29	8	2
9		21	7	2	74		22	7	2
22		14	7	2	75		15	7	2
31*		28	8	2	76*		29	8	2
32*		22	8	2	77*		23	8	2
33*		15	8	2					

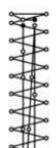

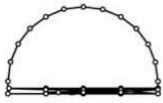

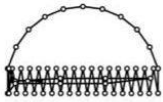

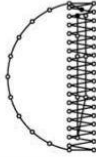
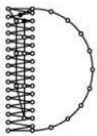

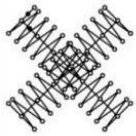
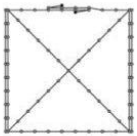
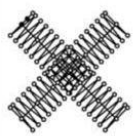
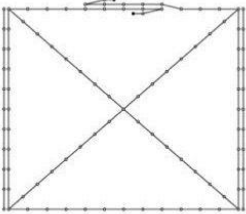

* 始针和终结针的位置在图案的中间。

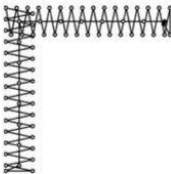
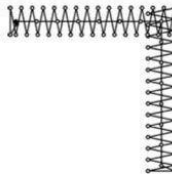
直线结					垂直曲折缝				
号码	花样	针数	尺寸 (mm)		号码	花样	针数	尺寸 (mm)	
			长度	宽度				长度	宽度
10		21	10	0.3	44		46	9	15
11		28	10	0.3					
12		28	20	0.3	45		70	9	25
23		35	25	0.3					
24		42	25	0.3					
25		45	25	0.3					

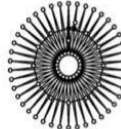
垂直结					垂直直线结				
号码	花样	针数	尺寸 (mm)		号码	花样	针数	尺寸 (mm)	
			长度	宽度				长度	宽度
26		28	3	10	28		19	0.3	10
27		35	3	10	29		21	0.3	10
40		32	3	16	30		28	0.3	10
41		36	3	16	46		27	0.3	20
42		44	3	20	47		44	0.3	25
43		68	3	24					

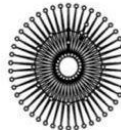
月牙结									
号码	花样	针数	尺寸 (mm)		号码	花样	针数	尺寸 (mm)	
			长度	宽度				长度	宽度
34		35	12	7	37		57	7	12
35		58	12	7	38		53	7	10
36		57	7	12	39		53	7	10

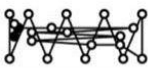
X 形结					交叉结				
号码	花样	针数	尺寸 (mm)		号码	花样	针数	尺寸 (mm)	
			长度	宽度				长度	宽度
48		70	10	10	50		84	16	16
49		93	9.6	9.6	51		105	30	26

L形结									
号码	花样	针数	尺寸 (mm)		号码	花样	针数	尺寸 (mm)	
			长度	宽度				长度	宽度
52		60	11.3	11.2	53		60	11.3	11.2
54		78	15.3	15.2	55		78	15.3	15.2
菊形缝									
号码	花样	针数	尺寸 (mm)		号码	花样	针数	尺寸 (mm)	
			长度	宽度				长度	宽度
56		106	9	9	59		104	10	10
57		116	9	9	60		114	10	10
58		127	9	9	61		124	10	10
圆眼钮孔									
号码	花样	针数	尺寸 (mm)						
			长度	宽度					
86		21	6	2					
87		28	6	2					
88		35	6	2					





如果想缝纫标准花样以外的其他缝纫花样，可以使用 PS-300B 创建原始花样。详情请咨询当地的兄弟销售办事处。

创建附加缝纫花样时请注意

如果反复缝纫（短循环运转）运针数（15 针以下）短的缝纫数据，则可能会引起上轴马达过热错误 [E150] 的现象。

1.4 List of sewing patterns(438F).

The sewing pattern shown below has been set in advance. As long as the needle can pass through the buttonhole, any sewing pattern can be selected. For sewing patterns without overlock stitches, trim the thread after sewing on one side and then stitch the other side.

号码	组孔数	花样	线数	包缝数	针数	尺寸 (mm)				
						X	Y			
1	2		6	—	12	3.4	0			
※1 54			6	—	12					
2			8	—	14					
※1 55			8	—	14					
3			10	—	16					
4			12	—	18					
※2 5			16	—	22					
※2 6			20	—	26					
※1 56				6	—			11	0	3.4
※3 7				6	—			12		
※3 23	10	—		16						
※3 8	12	—		18						
※3 9	3		5-5-5	—	21	2.6	2.4			
※3 24			7-7-7	—	27					
※3 25			5-5-5	—	21					
※3 26			7-7-7	—	27					
※1 57	4		6-6	1	18	3.4	3.4			
10			6-6	1	19					
※1 58			8-8	1	22					
11			8-8	1	23					
12			8-8	3	25					
13			10-10	1	27					
27			12-12	1	31					

※1 用于小孔纽扣。

※2 使用程序前，请检查组孔直径不小于 2mm。

※3 不可使用钮扣抬起弹簧。

号码	组孔数	花样	线数	包缝数	针数	尺寸 (mm)	
						X	Y
14 ※4	4		6-6	0	24	3.4	3.4
36 ※5			6-6	0	24		
28 ※4			8-8	0	28		
37 ※5			8-8	0	28		
15 ※4			10-10	0	32		
38 ※5			10-10	0	32		
29 ※4			12-12	0	36		
39 ※5			12-12	0	36		
59 ※1				6-5	1		
16		6-5		1	18		
60 ※1		8-7		1	21		
17		8-7		1	22		
30		10-9		1	26		
61 ※1				6-6	1		
18			6-6	1	19		
62 ※1			8-8	1	22		
19			8-8	1	23		
63 ※1			10-10	1	26		
31			10-10	1	27		
45			12-12	1	31		
20 ※4			6-6	0	24		
40 ※5			6-6	0	24		
32 ※4			8-8	0	28		
41 ※5			8-8	0	28		
33 ※4	10-10		0	32			
42 ※5	10-10		0	32			

※1 用于小孔纽扣。

※4 在完成一边缝纫后，钮扣夹就上升并进行拔线动作。为了将缝纫进行到底，在另一边的缝纫开始之前，请继续踩下脚踩开关；或在完成一边缝纫后，请再次踩下脚踩开关。

※5 在完成一边缝纫后，钮扣夹不上升而只进行拔线动作，并继续进行另一边的缝纫。

号码	纽孔数	花样	线数	包缝数	针数	尺寸 (mm)		
						X	Y	
※1 64	4		6-6	1	18	3.4	3.4	
※3 21			6-6	1	19			
※3 34			10-10	1	27			
※3※4 22			6-6	0	24	2.4		
※3※5 43			6-6	0	24			
※3※4 35			10-10	0	32			
※3※5 44			10-10	0	32			
46			6-7	1	19	3.4		3.4
47			8-9	1	23			
48			10-11	1	27			
49			12-13	1	31			

※1 用于小孔纽扣。

※3 不可使用纽扣抬起弹簧。

※4 在完成一边缝纫后，纽扣夹就上升并进行拔线动作。为了将缝纫进行到底，在另一边的缝纫开始之前，请继续踩下脚踩开关；或在完成一边缝纫后，请再次踩下脚踩开关。

※5 在完成一边缝纫后，纽扣夹不上升而只进行拔线动作，并继续进行另一边的缝纫。

用于带柄纽扣					
号码	花样	线数	针数	尺寸 (mm)	
				X	Y
50		6	12	3.4	0
51		8	14		
52		10	16		
53		12	18		

创建附加缝纫花样时请注意

如果反复缝纫（短循环运转）运针数（15 针以下）短的缝纫数据，则可能会引起上轴马达过热错误 [E150] 的现象。







1.5 Sewing pattern list (0806)



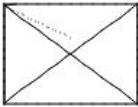
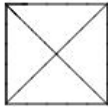



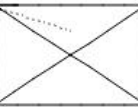
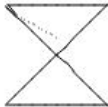
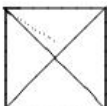
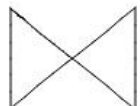
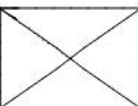
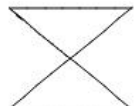

The sewing patterns shown below are pre-set and can be selected according to the specifications. (As long as it can be confirmed that it is within the working range of the presser foot and the feed plate, you can choose to use any sewing pattern.)

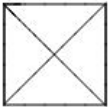
Use a presser foot and a feed plate that meet the requirements of various sewing patterns.

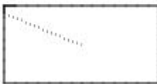
The length when the sewing size is 100%.

No.	落针图	针数	缝纫尺寸 mm		No.	落针图	针数	缝纫尺寸 Mm	
			纵	横				纵	横
1		54	30	40	9		38	20	20
2		46	30	30	10		38	20	20
3		113	20.1	38.4	11		33	18	18
4		97	20	28.8	12		33	18	18
5		81	20	19	13		30	18	18
6		52	11	9.4	14		30	13	18
7		48	25	25	15		39	25	35

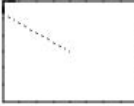
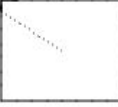
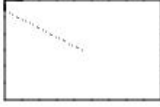
No.	落针图	针数	缝纫尺寸 mm		No.	落针图	针数	缝纫尺寸 mm	
			纵	横				纵	横
			8					48	25
17		96	30	40	25		52	20	20
18		84	30	40	26		42	30	40
19		66	25	35.1	27		38	25	35
20		62	25	30	28		36	25	30
21		56	20	30	29		46	28	28
22		68	28	28	30		36	20	25
23		66	20	28	31		36	20	25

24		62	20	25	32		50	15	15
No.	落针图	针数	缝纫尺寸 mm		No.	落针图	针数	缝纫尺寸 mm	
			纵	横				纵	横
33		56	16	25	41		48	20	40
34		65	30	35	42		33	27.2	37.1
35		30	15	15					
36		34	18	24					
37		36	20	24					
38		36	16	25					
39		42	25	25					

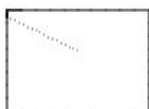
40		42	25	35					
-----------	-----------------------------------------------------------------------------------	-----------	-----------	-----------	--	--	--	--	--

项 目	机 型	0806 small pattern sewing machine
1	Trace form	Single needle flat seam
2	Maximum sewing speed	2,700rpm
3	Sewing size (X × Y)	maximum: 80×60mm;
4	Delivery drive mode	Intermittent feeding (pulse motor drive)
5	Needle gage	0.05-12.7mm
6	Number of needles	Memory 500000 pins
7	Maximum number of needles	20000 needles (1 procedure)
8	Store data that may be sewing	Memory: 999. U disk: unlimited
9	Lifting foot drive mode	Electromagnetic specification: pulse motor drive, air pressure specification: air pressure type
10	Foot lift	Electromagnetic specification: maximum 17 mm, air pressure specification: maximum 17mm
11	2 stage foot pressing	Left and right integrated foot pressing
12	Intermittent foot rise	22mm
13	Intermittent foot pressing stroke	$2 \leq 4.5$ mm, 4.5×10 mm or 0 (3mm when leaving the factory)
14	Shuttle hook used	Semi-rotating twice rotating shuttle (standard shuttle bought separately)
15	Wire buckle device	standard facility
16	Tangent device	standard facility
17	Data storage mode	Memory (quick erase memory), U disk
18	Number of user programs	50
19	Number of cyclic programs	9
20	Motor	AC servo motor 550W.

21	Weight	Head: about 88 kg, operating disk: about 0.6kg Control box: 14.2-16.2kg (depending on voltage)
22	Power	单相 100V/220V、3 相 200V/220V/380V/400V 400VA
23	Air pressure	0.5Mpa 1.81/min

※The maximum sewing speed should be reduced according to the sewing conditions.

1.6 Matters needing attention in safe use

● Task environment

Please do not use this control device in the following environments:

- supply voltage
 - ◆ The change of voltage will exceed the fixed voltage of $\pm 10\%$ of the place.
 - ◆ The power supply capacity cannot be guaranteed in the place of the specified capacity.
- interference of waves
- Next to it are radio emitters and high-cycle machines that emit strong radio waves and magnetic fields.
 - ◆ The place where the room temperature is between 0 °C and 50 °C.
 - ◆ A place where outdoor or sunlight shines directly.
 - ◆ The place next to the heater (electric heater).
 - ◆ A place where the relative humidity is between 5% and 95% (no condensation).
- Air
 - ◆ A place of corrosion or dust.
 - ◆ Places prone to gas or oil explosion.
- vibrate
 - ◆ If the place where the sewing machine is placed is prone to excessive vibration, place the control box elsewhere.

● installation

- control box
 - ◆ Please follow the instructions and install it correctly.
- appendix
 - ◆ If you want to install other accessories, please turn off the power supply and unplug the power supply.
- power line
 - ◆ Please do not use gravity to suppress the power cord or excessive distortion of the power cord.
 - ◆ Please do not put the power cord near the rotating part, at least leave the 25mm above.
 - ◆ Before the control box is connected to the power supply, please check whether the power supply voltage to be connected is the same as the voltage marked on the control box and determine the position before you can supply the power supply. If there is a power transformer, the same must be checked before the power supply can be supplied. At this time, the button power switch on the sewing machine must be placed in [OFF].
- landing

- ◆ In order to prevent electric shock events caused by noise interference and leakage, the grounding line on the power cord must be sure to do a good job of grounding.
- fixture
 - ◆ If you want to connect to the electrical accessories, please follow the instructions.
- dismantle
 - ◆ To remove the control box, you must first turn off the power supply and unplug the power supply.
 - ◆ When unplug, do not just pull the power cord, you must hold the plug in your hand and pull it out.
 - ◆ There is dangerous high voltage in the control box, so to open the control box cover, you need to turn off the power supply and wait more than 5 minutes before opening the control box cover.

● **Maintenance, inspection and repair**

- Repair and maintenance operations should be carried out by trained technicians.
- Be sure to turn off the power when changing the needle and shuttle.
- Use factory parts.

● **Other security countermeasures**

- Please do not touch the rotating and moving parts (especially needles and belt accessories) while the sewing machine is running, and be careful not to approach them in order to avoid danger.
- The control device shall not fall to the ground, let alone plug other objects into the gap.
- Please do not operate under the condition of removing the covers.
- If the control device is damaged or unable to function properly, it is necessary to ask experienced technical personnel to adjust, or check and repair, please do not run it until the failure has been eliminated.
- Please do not modify or change this control device by yourself.

● **Waste disposal**

- Please treat it with general industrial waste.

● **Warning signs and danger signs**

- The wrong behavior may be dangerous, to the extent of the indication described below.



- The representation of the marking symbol is described below.

	请遵照指示内容作业。		注意高压电（电击）的危险。
	注意高温。		务必接上接地线。
	绝对不要执行。		

1.7 Precautions for use

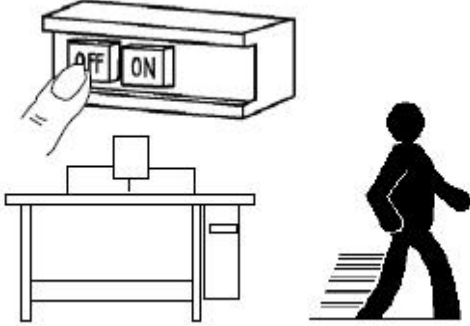
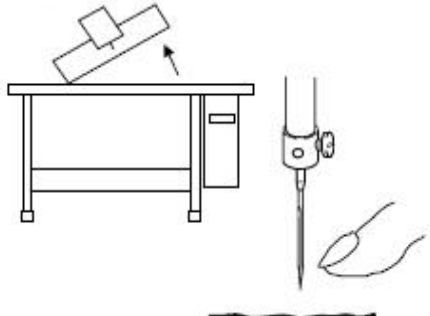
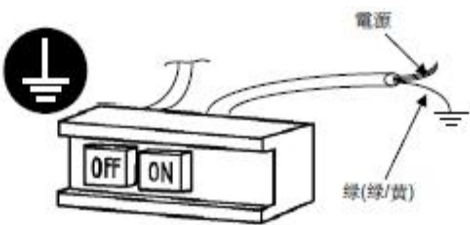
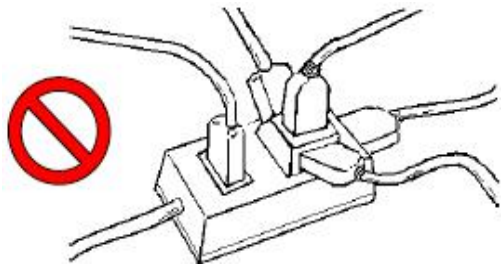
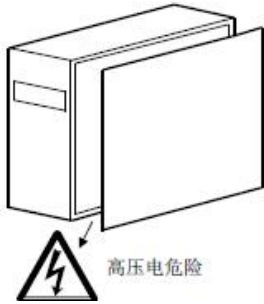

<p>1. When the hand presses the switch [ON], the foot must leave the pedal.</p> 	<p>2. Be sure to turn off the power when you want to leave your job.</p> 
<p>3. If you want to reverse machine head or change the needle or thread, be sure to turn off the power supply.</p> 	<p>4. Ground the ground wire.</p> 
<p>5. Do not use multi-jack extension cords for home use.</p> 	<p>6. There is dangerous high voltage in the control box, so wait 5 minutes before opening the control box cover.</p> 
<p>7. After replacing the motor, please refer to this information to set the installation angle of the spindle motor.</p>	
<p>8. Stay away from the machine that will cause high cycle noise interference.</p>	<p>9. If the external signal socket is used to connect the application accessory, the length of the cable should be as short as possible. The long cable may cause m</p>

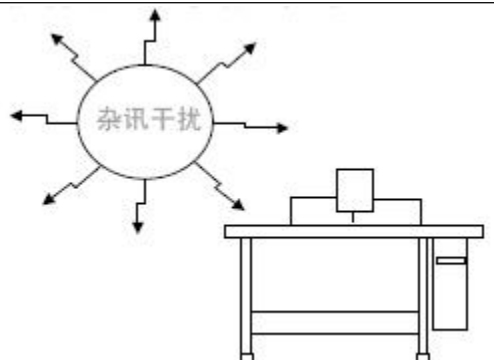
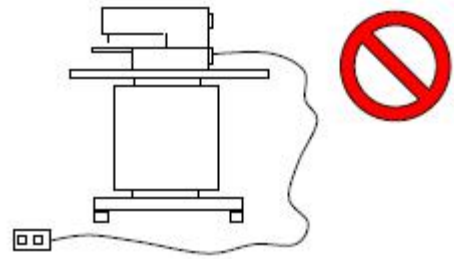
	<p>alfunction. Use the isolation cable for the cable.</p> 
<p>10. If the fuse is blown, please remove the cause and then replace the fuse of the same capacity.</p>	

1.8 Standardization

The function buttons adopt the industry-recognized graphic logo, and the graphics are international languages that can be recognized by users all over the world.



1.9 Mode of operation

The touch panel operation panel of the system adopts the industry's advanced touch operation technology, and the friendly interface and convenient operation bring innovative changes to the daily use of the user. The user can tap the screen with a finger or other object to complete the corresponding operation. Users should take care to avoid touching the screen with sharp objects during use to avoid permanent damage to the touch screen.

The function keys include a preparation key, an information key, a mode key, and a communication key. Refer to the descriptions in the following sections for specific operation methods.



Users should take care to avoid touching the screen with sharp objects during use to avoid permanent damage to the touch screen.

2 Instructions

2.1 Universal button

The buttons for general operation in all aspects of the system are as follows:

No.	Icon	Function
1		Confirmation key → Input interface enters the sewing interface / sewing interface to exit to the input interface
2		Information button → View version information and threading diagram
3		Communication key → U disk communicates with the panel to perform mutual copying of patterns or parameters
4		Set button → enter function interface
5		Pattern selection button → Open pattern file
6		Registration button → Register pattern file number
7		Name key → enter the name of the pattern
8		Electric presser foot height setting button → Set the electric presser foot height, the pneumatic presser foot is invalid
9		Medium presser foot height → Set the intermediate presser height
10		Adjustment button → Adjust the seam point
11		Threading key → Threading
12		Cancel button → Cancel current setting value / Exit current interface
13		Confirmation key → Save current setting value
14		Try sewing button → enter single step seam interface
15		Winding key → enter winding state

2.2 Basic operation

① Turn on the power switch

After the power is turned on, the data input interface is displayed.

② Select the pattern No. you want to sew.

The selected pattern No. will be displayed under the current interface. Press the pattern selection

button  and enter the sub menu to select the pattern No..

For details on the operation of pattern selection, see the section [2.8 Pattern Selection].



③ Set to a state that can be sewn

After pressing the ready button , the color

of the button is darkened  to enter the pattern confirmation interface. In this case, the sewing can be performed.

④ Start sewing

Place the sewing product on the presser foot, step on the pedal to lower the presser foot, start the sewing machine, and start sewing.

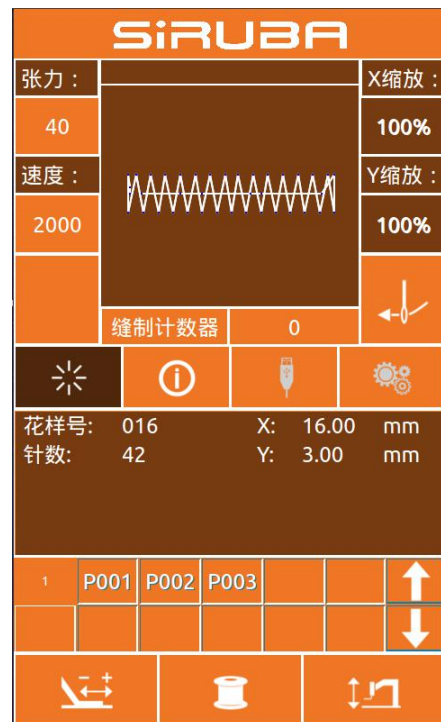

2.3 Ordinary pattern operation

(1) Sewing data input interface

The data input interface is shown on the right. For detailed function description, please refer to the function key description table.

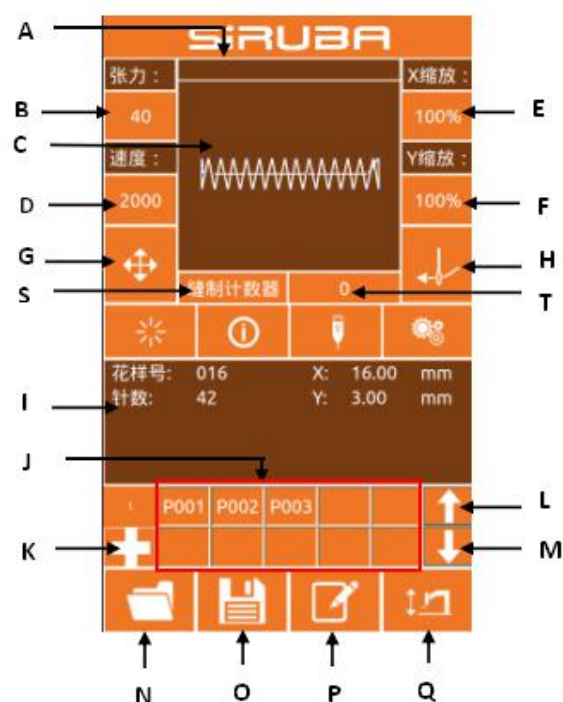

Function Description:

No.	Function
A	Pattern name display area
B	Tension key
C	Pattern display area
D	Speed key
E	X zoom rate key
F	Y zoom rate key
G	Adjust the seam point key
H	Threading key
I	Pattern information display area
J	P pattern shortcut key area
K	P pattern registration key
L	P-page flip key
M	P pattern page down key
N	Pattern selection key
O	Pattern registration key
P	Pattern naming key
Q	Electric presser foot setting key
S	Counter mode key
T	Count value key

(2) Sewing interface

Press to enter  the sewing interface as shown on the right. For detailed function descriptions, please refer to the function key description table.

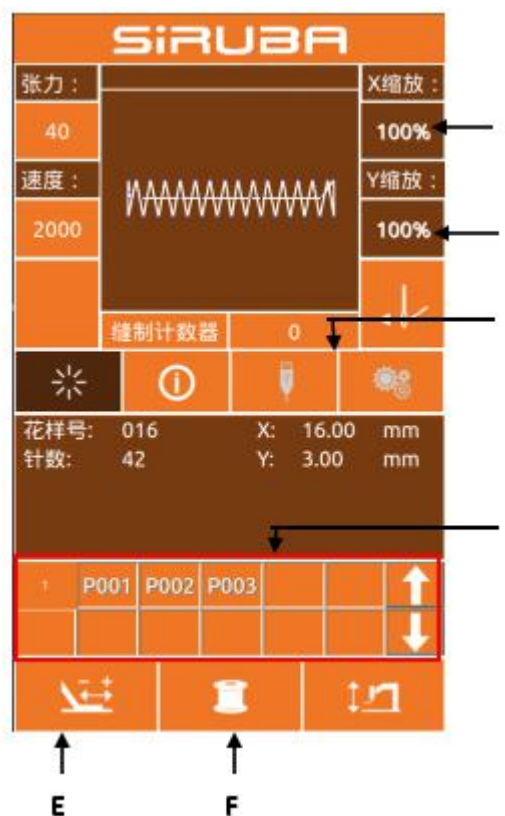

Function Description:

No.	Function
A	X zoom rate display
B	Y zoom rate display
C	Inoperable key
D	P pattern area is not operational
E	Trial key
F	Winding key
---	Others keys with the same input interface function

2.4 Pattern registration

Up to 999 ordinary patterns can be registered. Press  to enter the pattern registration interface (as shown on the right):

① Enter the pattern number

The number of the pattern you want to enter can be selected by the number keys. The pattern number range must be 201~999. If you enter another number, the number range will be displayed.

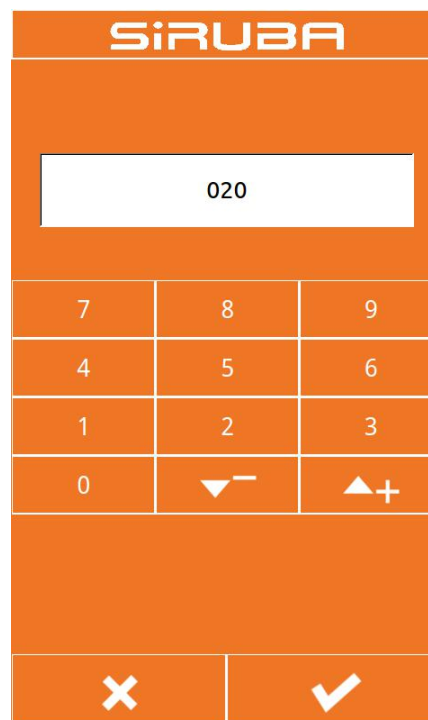

② Register new tricks

After confirming the pattern number and pressing , the previously displayed pattern data will be copied to the new registration pattern, and after the operation is completed, return to the new registration pattern data input interface.

If the entered number is already registered, it will prompt whether to overwrite the saved pattern.

Press the key  to exit the registration interface.

2.5 Pattern naming



Press  to enter the pattern naming interface (as shown on the right).

A	delete	Delete input characters one by one
B	Right shift	Cursor right
C	Shift left	Cursor left
D	Empty	Clear all characters currently entered

Select the character you want to enter



and press the end pattern naming operation.

The position of the character can be determined by moving the cursor, and the delete key can eliminate the position character.



2.6 Winding

① Installation bobbin

Insert the bobbin into the bobbin. As shown on the right.

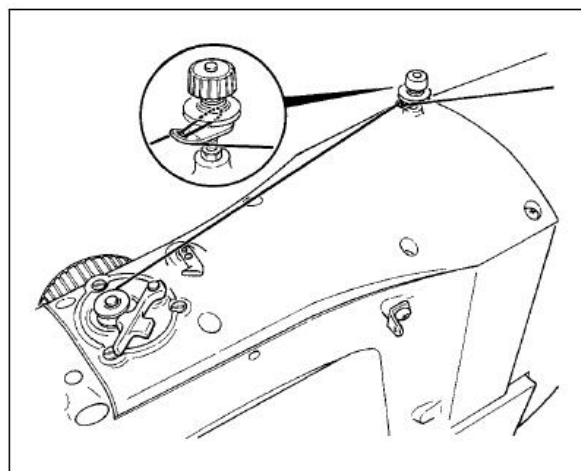

② Show bottom line winding interface

On the sewing interface, after the winding button  is pressed, the winding interface is displayed (as shown on the right).

③ Start winding

After stepping on the left pedal to press the foot, step on the start pedal to start winding.



④ Stop sewing machine

After the winding is started, when the starting pedal is stepped on again, the winding stops rotating. When the winding stops, the left pedal is pressed and the foot is raised to return to the sewing mode.



2.7 Threading

① Enter threading status

When the input interface or the sewing interface button  enters the threading state, the threading button turns red , and the screen changes as shown in the figure. In this state, the machine cannot perform other operations.



② Exit threading mode

After threading is finished, press the key



 again to return to the input interface or sewing interface.

2.8 Pattern selection

① Enter the pattern selection interface

Data input interface (as shown in Figure 1 on the right), click on the selection button A to enter the pattern selection interface (Figure 2).

Figure 2 information is as follows:

A	Pattern name
B	Pattern size information
C	Pattern display
D	Registered pattern number
	Flipping on the pattern
	Flip page
	Pattern deletion

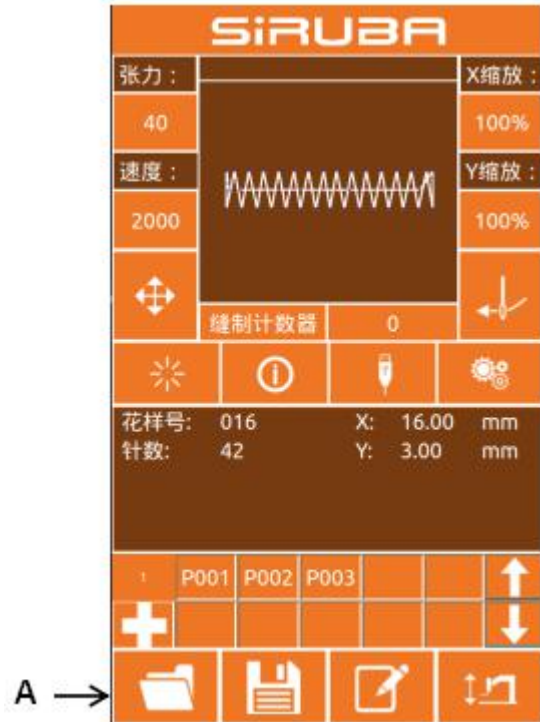



Figure 1

② Choose a pattern

The pattern number area D can display 25 pattern numbers per page; when a pattern number button is selected, the current pattern and information are displayed at the top. The pattern information includes a pattern number, a length in the X direction, a height in the Y direction, and a string named by the pattern (the unnamed pattern does not display a character string).

Press  to complete the pattern selection operation.

③ Pattern deletion

Select a pattern number button and press

 to delete the pattern.

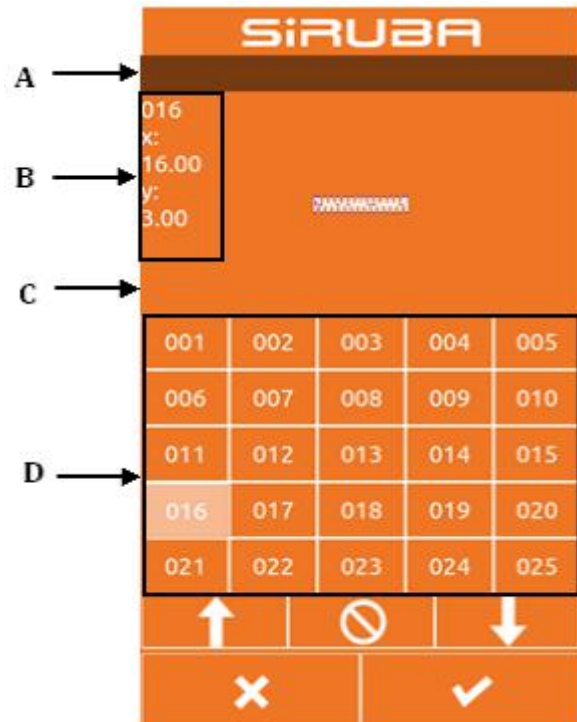

Figure 2

Note: The pattern is divided into the basic pattern and the common pattern: the basic pattern is the factory pattern; the ordinary pattern is the pattern that the user can make, copy or import the U disk, the pattern can be deleted and modified, but the deleted pattern cannot be retrieved. Please be cautious.

2.9 Sewing data setting

① Enter the sewing data setting interface

Press A, B, and C respectively in the data input interface to enter the zoom rate setting and speed limit setting interface respectively.

	Item	Input range	Initial value
A	Tension value	0~120	40
B	Sewing speed	400~2800rpm (The upper limit is set in the super setting parameter)	2000rpm
C	X direction zoom ratio	1.0~200.0%	100.0%
D	Y direction zoom ratio	1.0~200.0%	100.0%
E	Presser foot height	430F:10~17mm	14mm
		438F:6~13mm	10mm
		0806: 10~17mm	14mm

Note: The maximum speed limit is limited in “Super Settings → Parameter Settings → 3: Maximum Sewing Speed”.

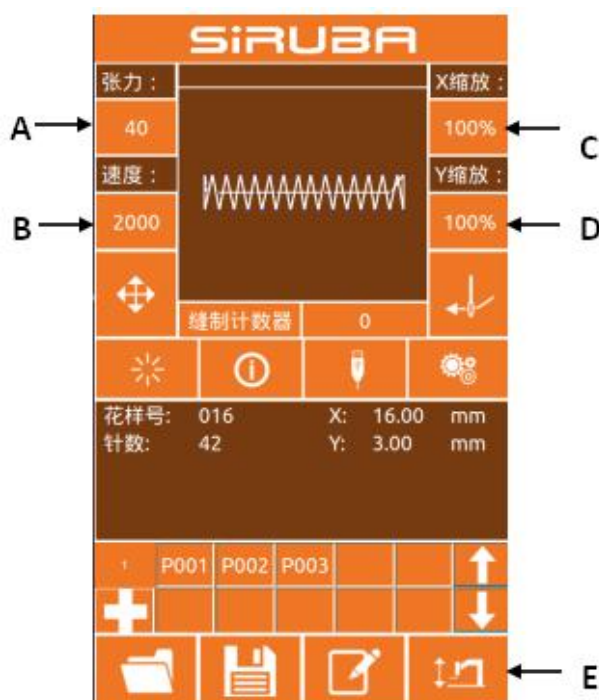

② Zoom rate setting

The picture on the right is the enlargement /reduction ratio setting interface. The upper part of the interface is set in the X direction, and the lower side is set in the Y direction.

A	X direction zoom rate display
B	Actual length value display in the X direction
C	Y direction zoom rate display
D	Actual length value display in the Y direction

Enter the desired value through the numeric keypad or the +, - keys. The entered number is inserted into the first digit of the displayed value. The previously entered digit is progressively one bit at a time. Press the OK



button to complete the operation and return to the data input interface.

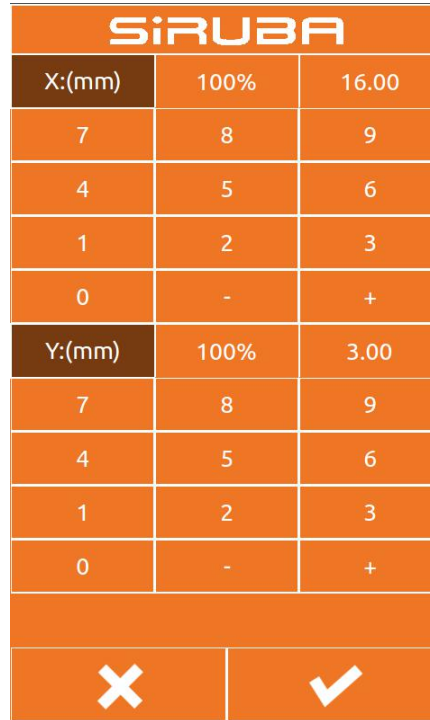

③ Speed value setting

Operation as above

④ Medium presser height setting

Operation as above

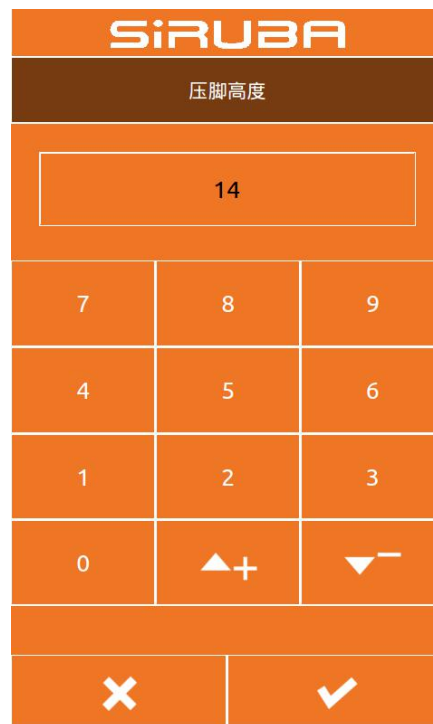



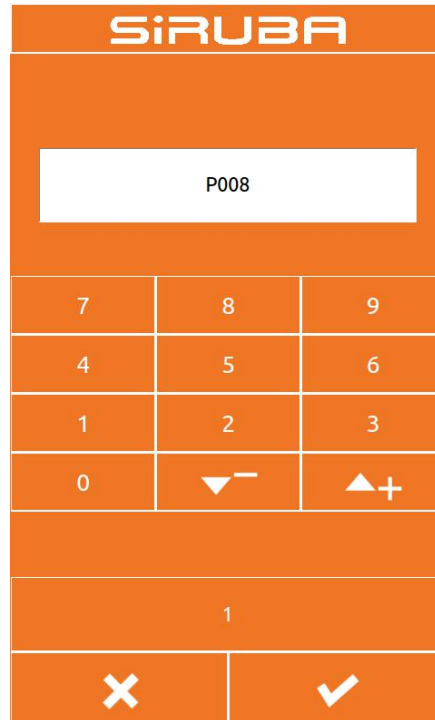

2.10 P pattern registration

① Enter the P pattern registration interface



When the normal pattern is displayed under the data input interface, press  to enter the P pattern registration interface, as shown in the right figure.



② Enter the P pattern number

Enter the number you want to register by using the  ~  ten-digit keyboard or ,  key. If you have entered the registered pattern number, you will be prompted that the number is already occupied. In this case, the user needs to re-enter the number you want to register.

③ Select folder number

The P pattern number can be registered in 26 folders, and each folder can hold up to 10 P patterns. A is the current folder, press the  and  keys to switch folders.

④ Determine the pattern number

Press the  to complete the P pattern registration operation and return to the P pattern data data input interface as shown.

⑤ Delete P pattern

Select the P pattern number and press the  to delete the current P pattern number.

⑥ View registered P pattern

Press the following two buttons to see how many P

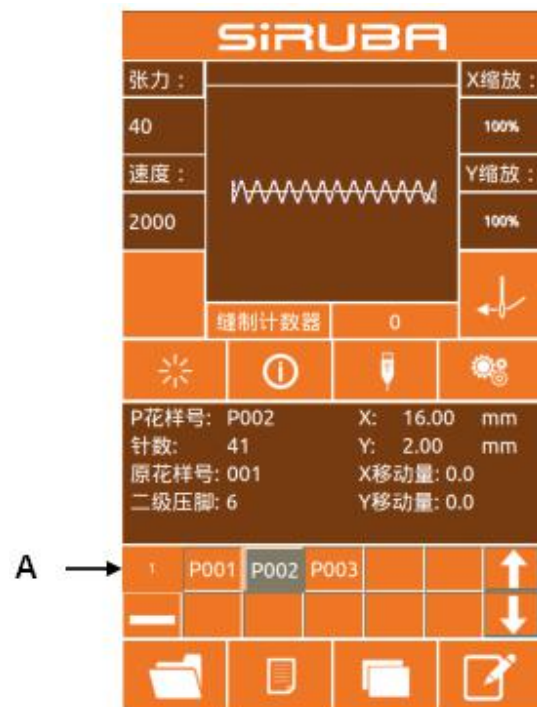

patterns have been registered.

Users can register up to 255 P patterns.





:P pattern flipping



:P pattern page down

2.11 Trial operation







① Display sewing interface

On the data input interface, after pressing the ready button , the ready button changes to the status , indicating that the sewing interface has been entered.

② Display trial seam interface



Under the sewing interface, press the

key  to enter the trial seam interface (as shown on the right):

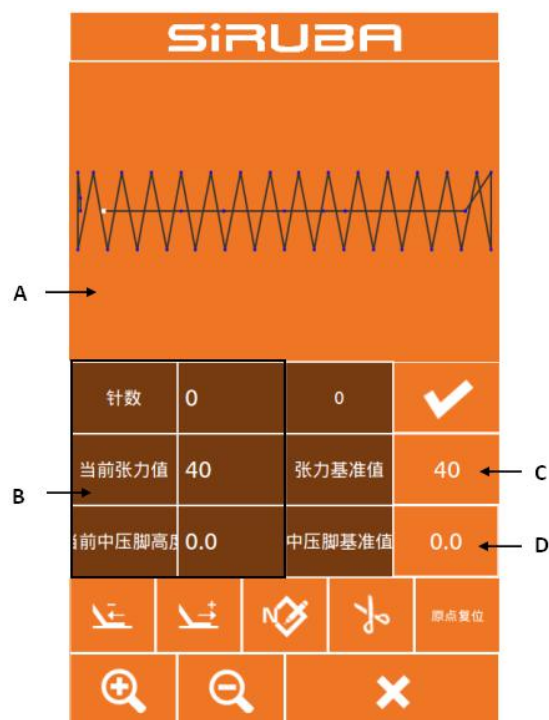
A	Pattern display area
B	Pattern info display area
C	Tension reference setting button
D	Middle-presser foot refer setting button
E	Home position reset button
	Single needle back button
	Single needle advance button
	N needle moving button
	Trimming button
	Graphic display zoom button
	Graphic display zoom button



③ Start trial stitching

After entering the trial seam interface, the presser foot is lowered, and the presser foot back button  and the presser foot forward button  are used to determine the shape.

Or use the N pin forward button  to move directly to the Nth pin.

④ Trial seam interface start sewing

At the trial seam interface, the start pedal can be stepped directly at any position, and the

machine will start sewing from the current position and return to the sewing interface.

⑤ End trial seam

After pressing the Cancel button  to exit the trial seam interface, return to the sewing interface and return to the starting position of the pattern.

2.12 Counter operation

① Display counter interface

In the input interface or sewing interface, the position of the counter is displayed as shown in Figure A and B.

A	Counter mode key	1:sewing counter 2:Needle counter
B	Count value display key	1:Number of sewing parts 2:Number of stitches

The user can directly click the A counter mode button to quickly switch the “counting counter/counter counter” and display the corresponding “number of pieces/number of stitches” at the position of the B button.

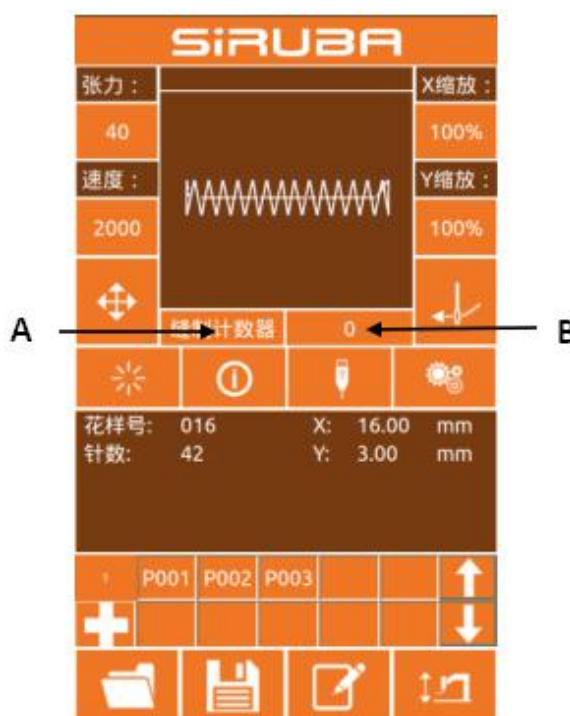

② Counter clear operation

Click button B to pop up the recounting interface. As shown in the figure, click the C button, the counter is cleared, and return to the previous interface input interface/sewing interface.

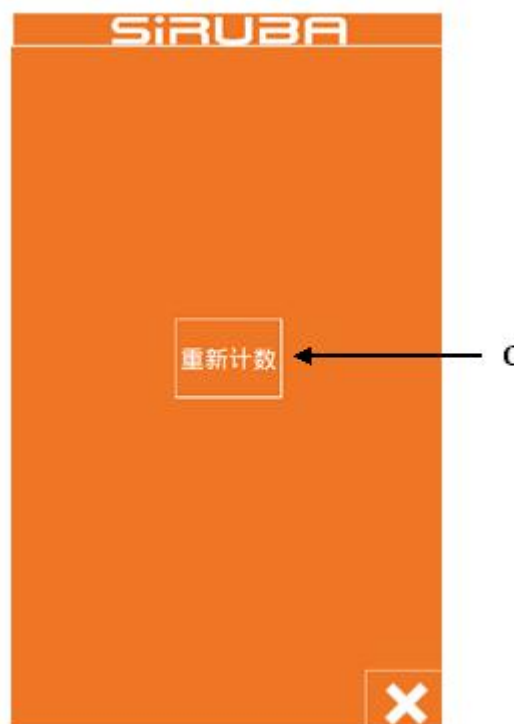

③ Set counter operation

Click the D button in the setting interface to enter the counter setting interface.

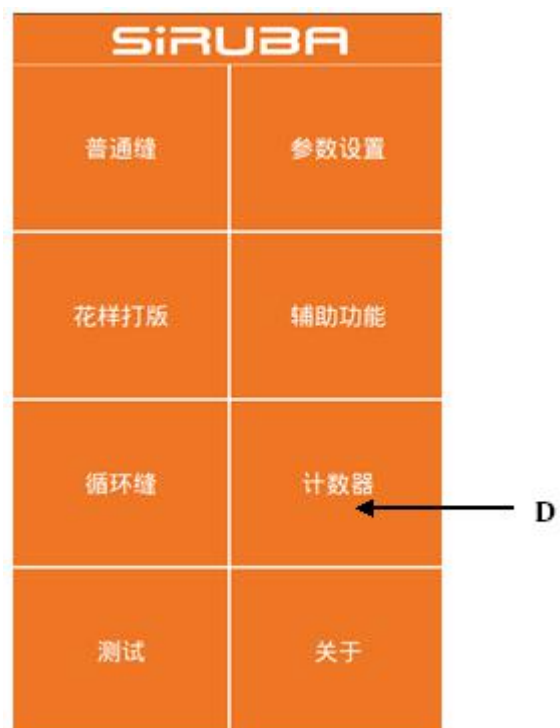

E	Sewing counter mode
F	Piece current count value
G	Sewing counter maximum
H	Needle counter mode
I	Needle count current value
J	Needle counter maximum

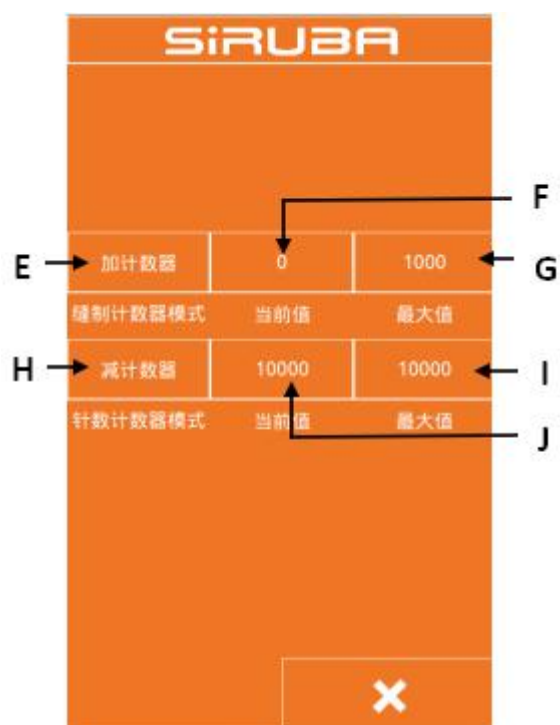

1.Set the counter type

Click the E or H button to enter the counter mode setting interface.



The mode can be set to "up counter / down counter / no counter", after the mode setting is completed, press the button , Go back to the previous screen.



2.Set count value

Click F/J or G/I to set the current count value and the maximum count value

respectively. Through  ~ 

+ number key or ,  key to put number.

Note: The maximum value of the sewing counter is 9999 pieces, and the maximum value of the needle counter is 65000 pieces.

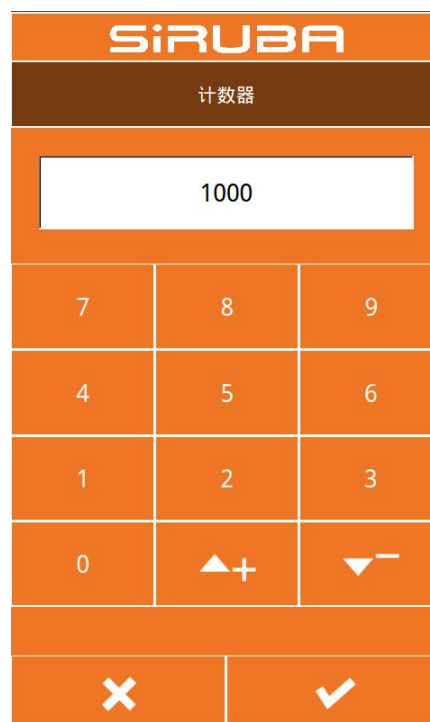

2.13 Adjust the stitching point operation

① Enter the adjustment sewing point interface

In the data input interface, after pressing the adjust sewing point button , Enter the adjustment sewing point interface. As shown on the right.

A	Simulated stitch back button
B	Simulated sewing advance button
C	Current number of stitches
D	Move the needle number selection button once
E	Adjustment data display
F	Display graphics area
G	Adjust the stitching point to move the keyboard
H	Lift the middle presser foot button

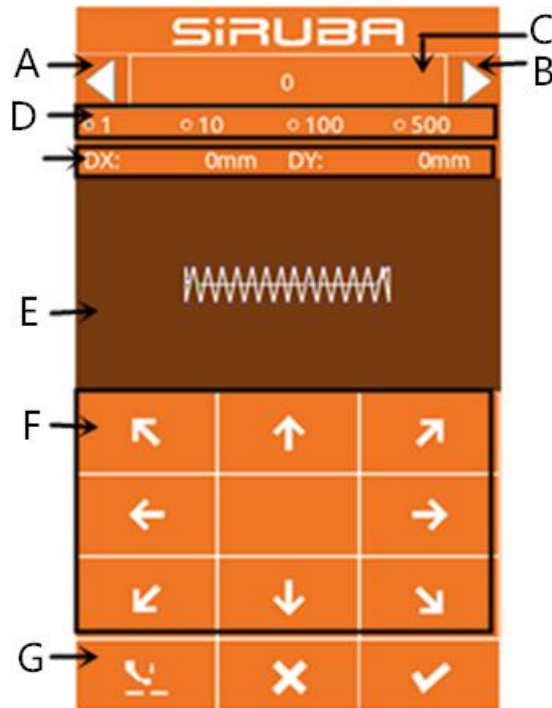

② Start adjusting the stitching point

Press the moving keyboard of the G area to move the seaming point to make the machine aim at the seaming point of the template. After finishing the seaming point, you can press the A and B buttons to “simulate the button” to check if it is aligned. The simulation walks by default by one stitch at a time. You can select to move 10 stitches, 100 stitches or 500 stitches at a time by clicking the D area radio button.

Note: The standard for the seaming point has been aligned: there is no deviation between the needle and the sewing path of the pattern. If there is a deviation, the adjustment still needs to be continued. After confirming the adjustment, press the

button  to confirm the offset.

③ End trial sewing

After pressing the Cancel button  to exit the adjustment interface, return to the input interface.

2.14 Emergency stop

After the emergency stop switch is pressed, press the enter key to enter the sewing interface. You can use the trial sewing interface to advance the needle number, rewind or trim the thread. For the operation steps, refer to [2.11 Trial Sewing Operation].

3 Fast (P) pattern operation

3.1 P pattern data input

The quick pattern is abbreviated as P pattern, which consists of a common pattern and related pattern sewing parameters (X zoom rate, Y zoom rate, speed limit, etc.). P-patterns do not need to be set each time.

The P pattern data input interface is as shown on the right.

Up to 255 P patterns can be registered.

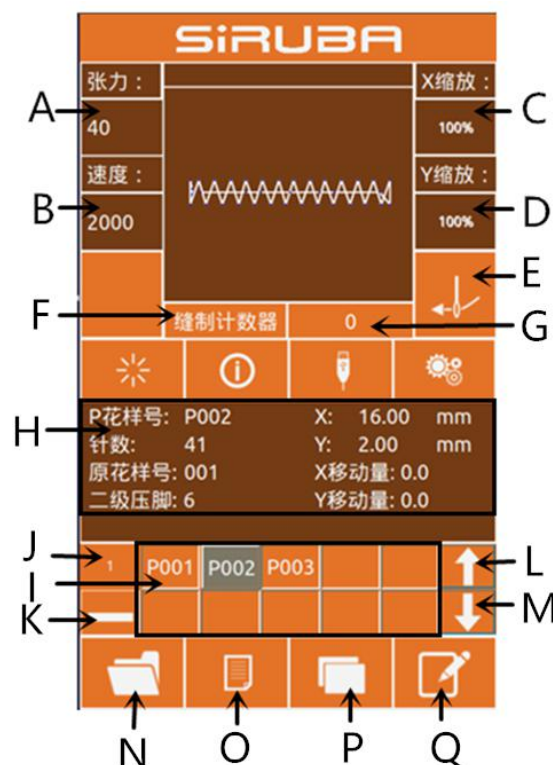

Function Description:

Serial number	Function	Content
A	Tension value	Display current pattern tension
B	Speed value	Display current pattern speed value
C	X zoom rate	You can enter up to 14 characters
D	Y zoom rate	After pressing, the outer presser foot is lowered
E	Threading	When pressed, the red  is threaded and no other operations can be performed.
F	Counter mode	It is divided into sewing counter and needle counter. Click button to quickly switch counter mode and count display.
G	Counter value	Display the corresponding current count value according to the counter mode
H	P pattern information display	Displayed as the current P pattern sewing information.

I	Registered P pattern	The button can quickly switch the P pattern.
J	P pattern number of pages	The number of pages of the current P pattern is displayed, and the button can sequentially switch the P pattern page number.
K	P pattern delete button	Click this button to delete the selected P pattern.
L	P pattern on page	Click the button P to turn the page
M	P pattern under the page	Click the button P to turn the page
N	Ordinary pattern selection button	Click the button to select the registered common pattern
O	Ordinary pattern registration button	Register a new general pattern
P	P pattern copy button	Can copy the current P pattern content to an empty pattern number
Q	Pattern naming key	Can name the current pattern

3.2 P Pattern Editing

① Enter the P pattern editing interface

Press this button  to enter P pattern editing interface (as shown on the right)





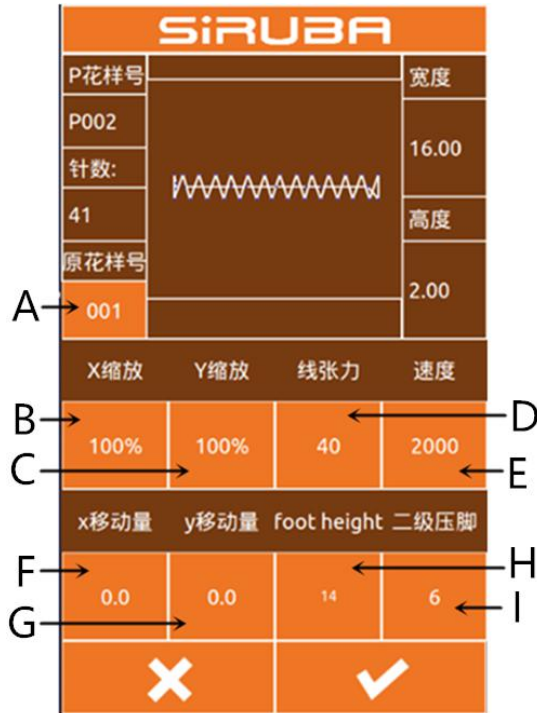

② Edit project data changes

Select the item you want to change and set the value

	Item	Input range	Initial value
A	Original number	---	---
B	X direction zoom	1%~400%	100.0%
C	Y direction zoom	1%~400%	100.0%
D	Sewing tension	0~120	40
E	Sewing speed	400~2800rpm	2000rpm
F	X offset	-99.9~99.9	0.0mm
G	Y offset	-99.9~99.9	0.0mm
H	Middle presser foot height	0.0~7.0mm	2.0mm
I	Secondary presser foot	0~10	6mm



③ Identify data changes

Take the X direction offset as an example, through  ~  +  number keyboard or  key to input number, press the confirm key  to finish. : Represents positive and negative values;

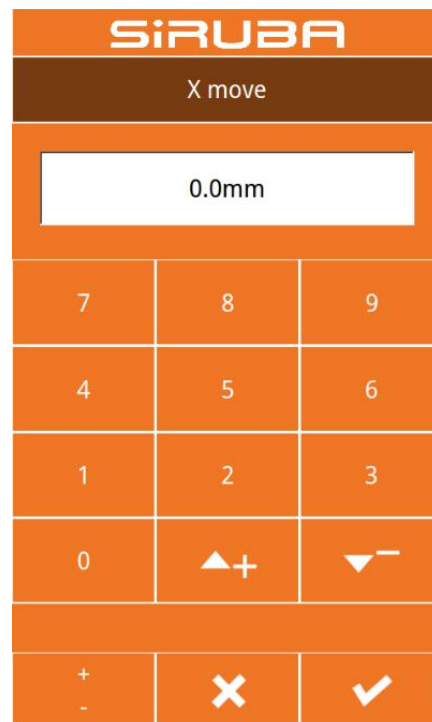

④ Exit editing

Press the Exit key  to close the P pattern editing interface and return to the data input interface.

3.3 P Pattern paste





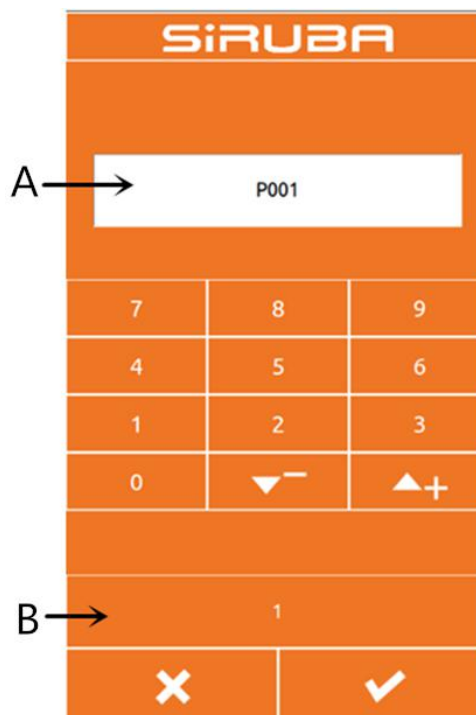

① Select the copied pattern

Press  to enter the P pattern copy interface (as shown on the right).



② Enter the newly registered pattern number

A is the empty number automatically selected by the system, and B is the number of pages. The user can directly copy the current P pattern to the

number; , or can
 through  ~  + number
 keyboard or 、 key to
 put the destination number you want
 to copy. The registered pattern number
 cannot be registered repeatedly, and
 the system will prompt an error. B
 button can change the number of
 pages, Press the button  to
 confirm the copy and return to the P
 pattern input interface.

3.4 P Pattern sewing

In the P pattern data input interface,

press  to enter the sewing interface.

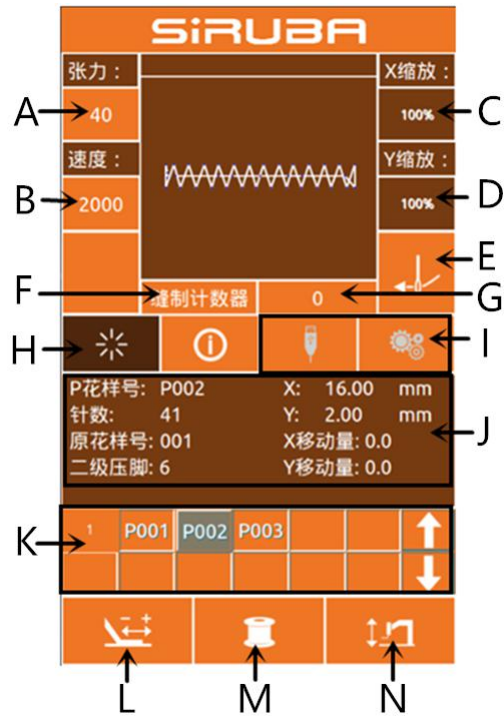

Function Description:

Item	Function	Content
A	Tension button	Press the button to enter the tension setting interface to set the sewing tension value.
B	Speed button	Set the current sewing speed.
C	X direction zoom display	Displays the X zoom ratio of the current pattern.
D	Y direction zoom display	Displays the Y scaling rate of the current pattern.
E	Threading button	When pressed  , the button turns red and enters the threading state. No other operations can be performed at this time.
F	Counter mode button	Press the button to quickly switch the “ Sewing Counter/Needle Counter” .
G	Count display button	According to the mode of the F button, the corresponding count is displayed. After pressing, the clear interface can be entered, and the current count can be cleared.
H	Pattern confirmation button	Switch "pattern input status/sewing status".
I	Inoperable button	The current state is not operational.
J	Pattern information display	Displays the parameter values of the current pattern.

K	Inoperable button	The current state is not operational.
L	Trial sewing button	Press the button to enter the trial sewing interface and confirm the pattern stitch.
M	Winding button	Press to enter the winding interface.
N	Medium presser foot height button	Press the button to enter the intermediate presser height setting interface to set the height of the intermediate presser.

4 Combination (C) pattern operation

4.1 C Pattern data input

The combination pattern is abbreviated as C pattern, which is composed of a set of P patterns, and each group of C patterns can input up to 6 sub-patterns. A total of up to 50 sets of C patterns can be registered.

As shown on the right.

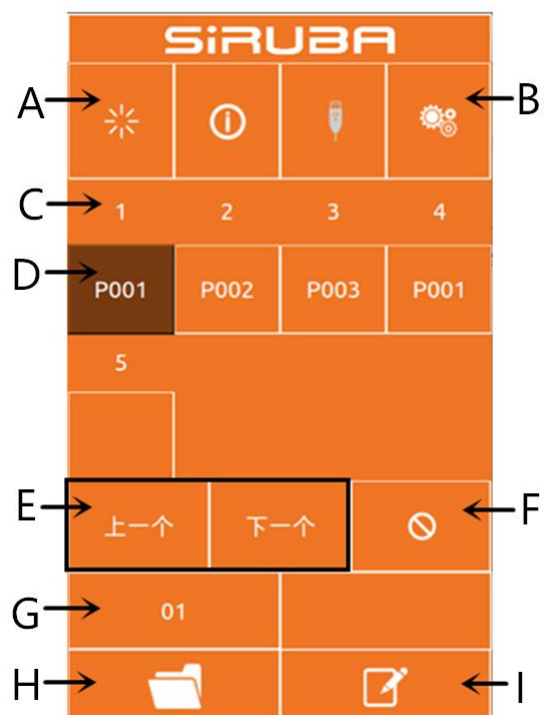

Function Description:

No.	Function	Content
A	Enter	Entering the sewing state
B	C pattern copy	You can copy the current C pattern content to an empty pattern number.
C	Sewing order display	The sewing order of the currently selected pattern is displayed, and the blue color is displayed as the starting sewing pattern.
D	C pattern selection	Press to enter the C pattern editing interface, you can choose to enter a P pattern.
E	Page key	Up to 30 C pattern can be registered, and up to 6 patterns can be displayed per page.
F	Delete key	Delete C pattern sequence
G	C pattern number selection	The currently selected pattern number is displayed on the button, and the C pattern selection interface is entered after pressing.
H	C pattern registration	Register a new combination pattern.
I	Pattern naming	Enter the string you want to name
J	C pattern name	The C pattern name is displayed.

4.2 C pattern editing

① Enter the C pattern editing interface

In the C pattern data input interface, press A to enter the C pattern editing interface.

In the initial state, the P pattern is not registered as the sewing pattern, so the first pattern is displayed in a blank state.

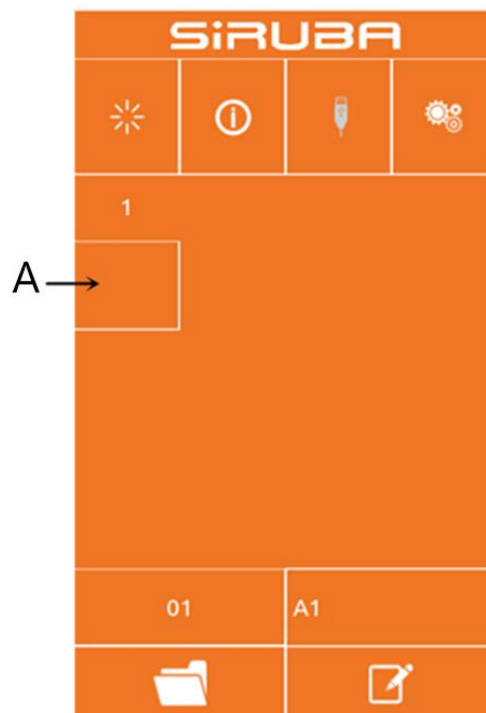

② Selection pattern

The picture on the right is the C pattern editing interface. Select the P pattern of the B area you want to register, and

press the OK button  to end the selection.

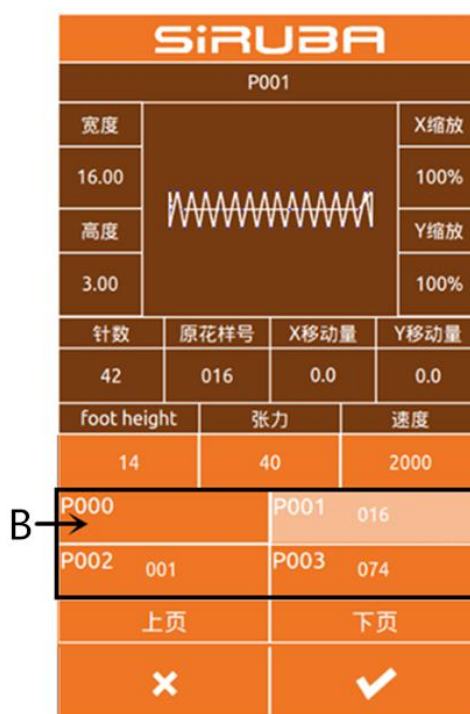

③ Repeatedly registering the remaining patterns

After a pattern registration is determined, the next pattern selection key C is displayed as shown above, and the operation is the same as above, and other remaining patterns can be repeatedly registered.

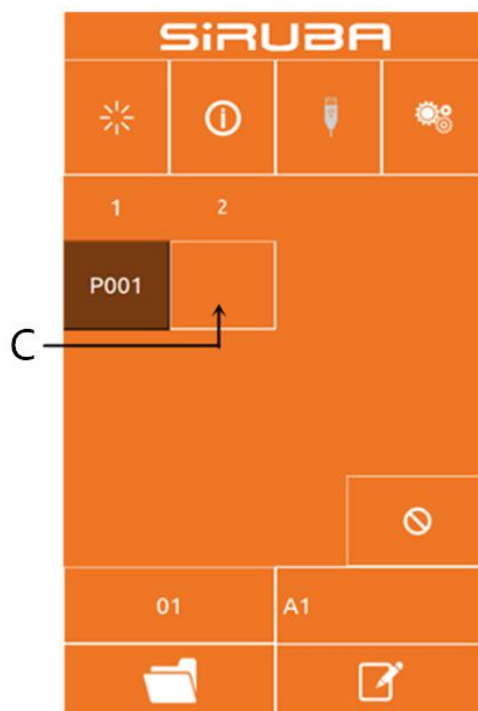

4.3 C pattern selection

① Enter the C pattern selection interface

As shown on the right, press icon A to enter the C pattern selection interface.



② Select C pattern number

The picture on the right is the C pattern selection interface. After pressing the B button, the P sub-pattern data input under the current C pattern can be sequentially changed.

Determine the C pattern number key C you want to select, and press the OK

button  to end the selection.

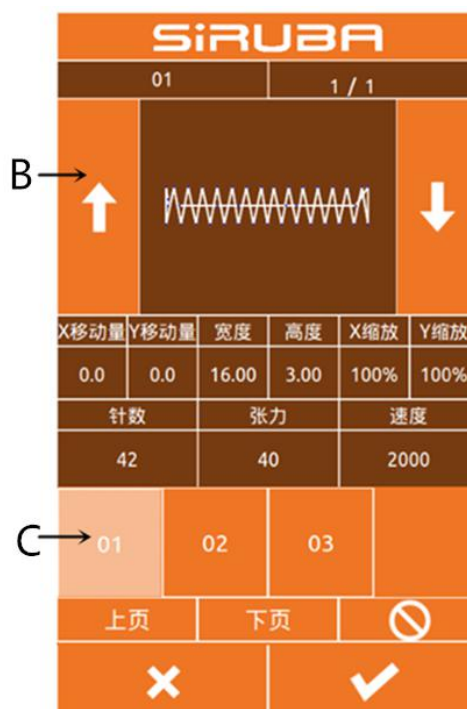

4.4 C pattern sewing

In the C pattern data input interface, press



to enter the sewing interface (as shown on the right).

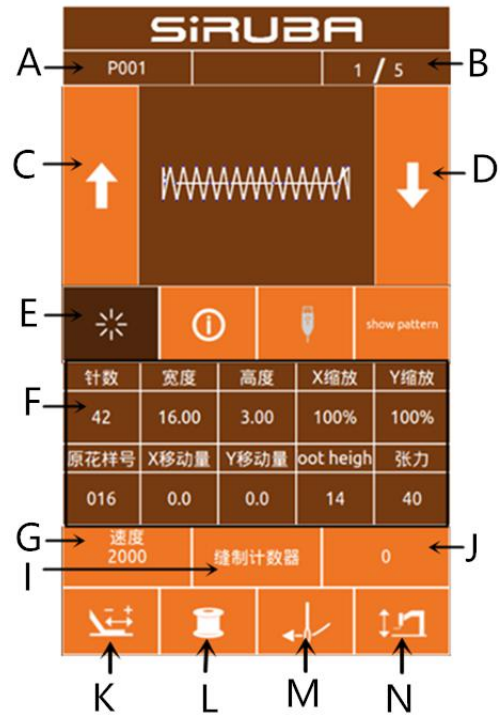

Function Description:

No.	Function	Content
A	Sewing shape number display	Displays the sub-pattern number registered under the current C pattern.
B	Sewing order display	Display the sewing sequence number in the current sewing pattern
C	Sewing pattern switching button	Press the back sewing pattern to switch to the previous pattern of the current sequence.
D	Sewing pattern switching button	Press the back sewing pattern to switch to the next pattern in the current sequence.
E	Pattern confirmation button	Switch the C pattern input interface status and sewing interface status.
F	Pattern information display	Displays parameter information of the current sub-pattern in the current sewing sequence.
G	Sewing speed key	Sets the sewing speed of the current sub pattern in the current sewing sequence.
H	Medium presser foot height button	Sets the intermediate presser height of the current sub-pattern in the current sewing sequence.
I	Counter mode button	Set the current count mode, “Sewing count/number of stitches” .

No.	Function	Content
J	Pattern count display	According to the setting of I, the corresponding count "number of pieces / number of stitches" is displayed.
K	Trial sewing button	Press to enter the trial sewing interface, confirm the stitching trend of the current sub-pattern in the current sewing sequence.
L	Winding button	Press to enter the winding interface.
M	Threading button	When pressed, the button turns red  and enters the threading state. No other operations can be performed at this time.
N	Medium pressure foot lift button	It can control the lifting of the intermediate presser foot.

5 Pattern editing

5.1 Enter the pattern editing mode

Press the normal sewing to switch the data input interface and mode selection interface (as shown on the right), in which you can perform some detailed settings and editing operations.





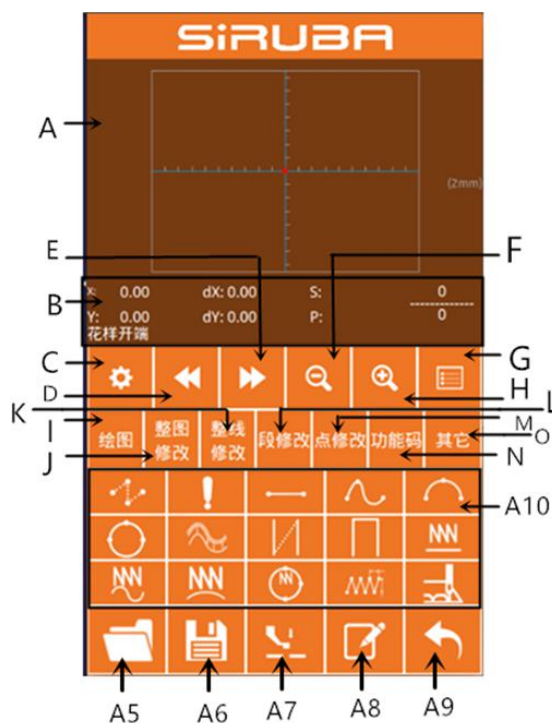











Press the pattern play button to enter the pattern editing interface.



Function Description:

No.	Function	Content
A	Pattern display area	Display pattern
B	Current needle position status information display area	Display the current needle position information
C	Property settings	Can set attributes such as back stitch
D	Back feed	Move the current needle position backward
E	Forward feed	Move the current needle position forward
F	Zoom out	Zoom out the pattern
G	Zoom in	Enlarge the pattern
H	function list	Display the functions in the play version in the form of a list
I	Drawing	A10 area shows the drawing related button
J	Whole picture modification	A10 area shows the whole map modification related button
K	Complete line modification	A10 area shows the entire line modification related button
L	Segment modification	A10 area shows the segment modification related button
M	Point modification	A10 area shows point modification related button
N	function code	A10 area displays function code related buttons
O	other	A10 area shows other related buttons
A5	turn on	Open the pattern file
A6	save	Save the current display pattern as a pattern file
A7	Intermediate presser lift	Lifting or lowering the intermediate presser foot
A8	name	Name the pattern
A9	drop out	Exit the pattern

No.	Function	Content
A10	Dynamic button display area	According to different choices of buttons (I, G, K, L, M, N, O), the corresponding related buttons are displayed.
	Empty delivery	Draw empty
	Point stitch	Draw a point seam
	Straight seam	Draw a straight line
	Curved seam	Draw a curve
	Circular seam	Draw an arc
	Round seam	Draw a circle
	Multiple seam	Draw multiple seams
	Co-directional double seam	Drawing the same direction double seam
	Reverse double seam	Draw reverse double seam
	Straight zigzag	Draw a straight zigzag
	Curved zigzag	Draw a curve zigzag
	Circular zigzag	Draw a circular zigzag
	Round zigzag	Draw a circular zigzag
	Straight zigzag 2	Draw a straight zigzag 2 (multiple points can be set for each segment)
	Jump seam	Draw a jump seam

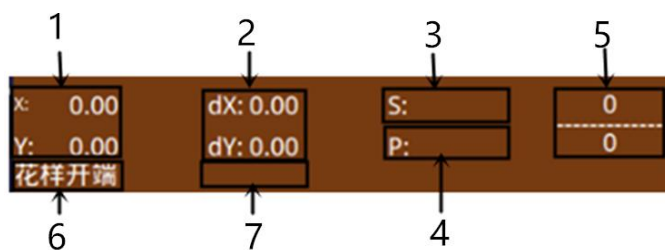

No.	Item	Content
1	Absolute coordinates	Indicates the absolute coordinates of the origin from the current needle position.
2	Relative coordinates	Indicates the relative coordinates of the current needle position.
3	speed	Indicates the sewing speed or the idle speed of the current point.
4	interval	Indicates the current factor sewing stitch length.
5	Contacts	The numerator indicates the current number of stitches, and the denominator indicates the total number of stitches.
6	Needle type	Indicates the type of needle drop position.
		The beginning of the pattern indicates the starting position of the pattern.
		The middle point of the line segment indicates the midway point of a line (that is, it is not a vertex or a line segment terminal).
		The vertex is the vertex of the polyline.
		The line segment terminal indicates the end position of a line.
7	Line or function code type	When sewing data, the type of the line (empty feed, broken seam, curved seam, etc.) is displayed. When the function code is displayed, the type of the function code (tangent line, etc.) is displayed.

5.2 Pattern Edition

Using the pattern editing function, enter the following pattern.

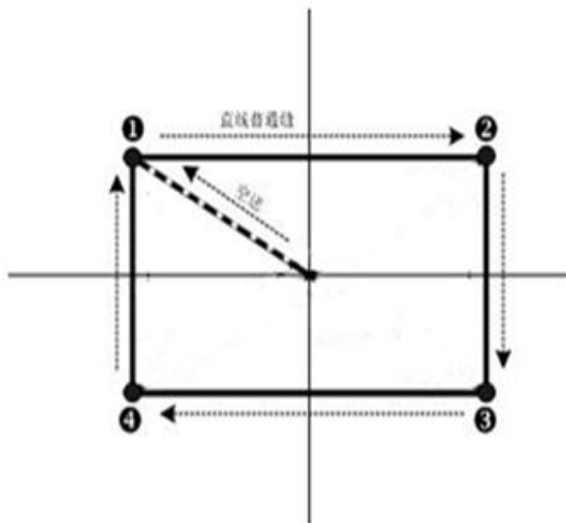

Input point:

	X (mm)	Y (mm)
1	-10.00	5.00
2	10.00	5.00
3	10.00	-5.00
4	-10.00	-5.00

Input order: as indicated by the dashed arrow in the left figure.

① Input for jumping

In the pattern editing standard interface, press jump button , it shows jump setting interface (As shown on the right).

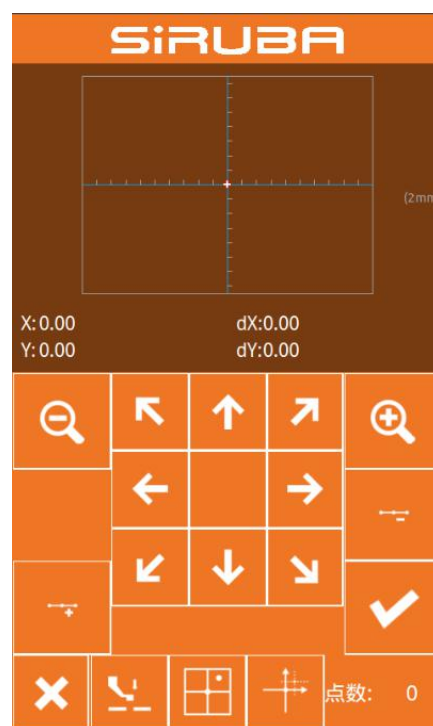

In the empty position designation interface, use the move button to move the cursor (needle position) to (-40, 25), press the 1 button  to confirm, return to the pattern editing standard interface and display the empty feed stitch (as shown on the right).

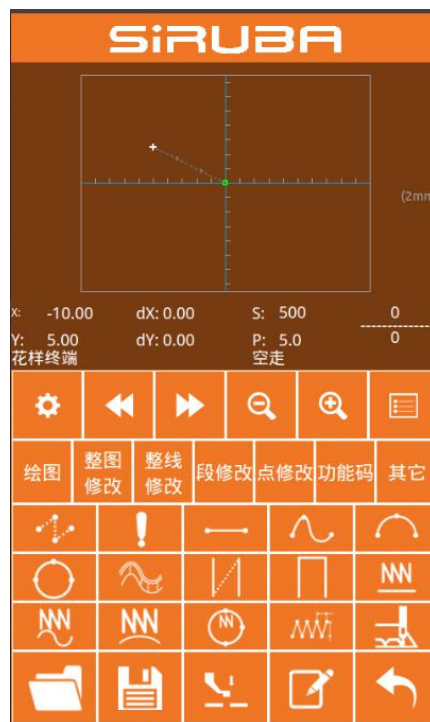

② straight ordinary sewing input

After Pressing the seam key in the pattern editing standard interface , Enter the straight line normal stitch setting interface, as shown on the right. Press the 3, 0 number keys in sequence to change the stitch length to "3.0", press the enter key to save and return. Straight line normal seam setting interface.

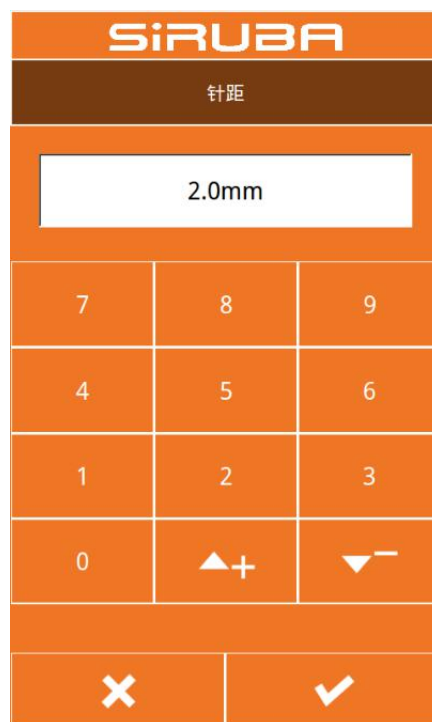

After confirming the needle distance

shows “3.0mm” ,press confirm button , enter the straight line normal seam position setting interface.

In this interface, press the move button to move the cursor (needle position) from 1 to 2,

then press the insertion point button.  Repeat the above movement operation to move the cursor in the order of 1→2→3→4, as shown in the right figure.

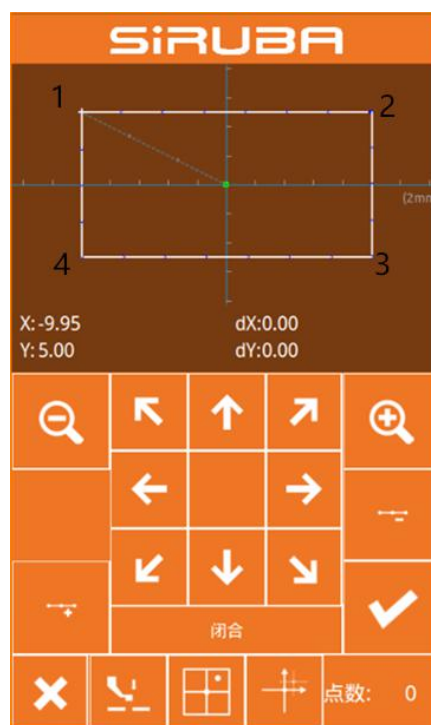

After confirming the pattern, press this

button  to make the pattern data and return to the pattern editing standard interface, it shows the pattern.

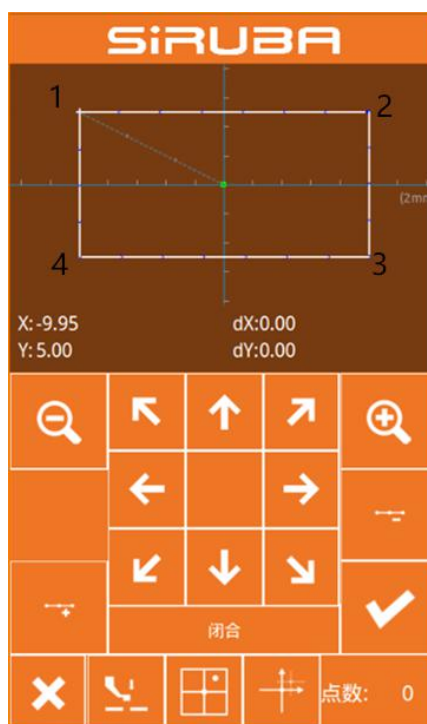

③ Save pattern

Press this button , enter the pattern design save interface and save the edited pattern, as shown on the right.

The system automatically sets the sample number, and the user can also enter the desired value through the numeric keypad. Press this button

 to save the pattern.

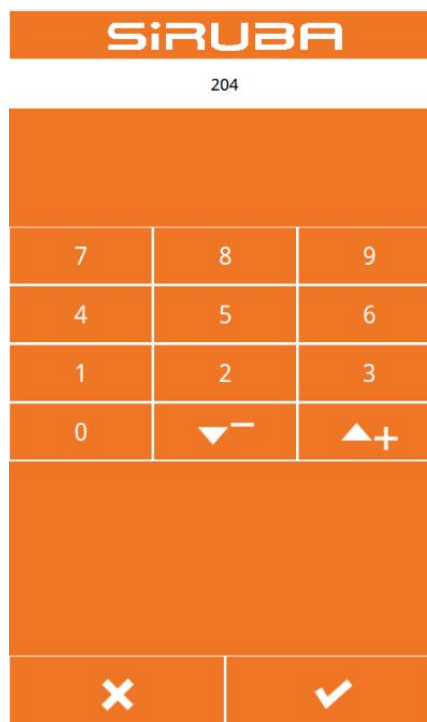

5.3 Pattern modification

1: Draw pattern

- (A): Draw jump
- (B): Draw point sewing
- (C): Draw straight line
- (D): Draw curve line
- (E): Draw an arc
- (F): Draw circle
- (G): Draw multiple sewing
- (H): Drawing the same direction double sewing
- (I): Draw reverse double sewing
- (J): Draw a straight zigzag
- (K): Draw a curve zigzag
- (L): Draw a circular zigzag
- (M): Draw a circular zigzag
- (N): Draw a straight zigzag 2 (multiple points can be set for each segment)
- (O): Draw jump sewing

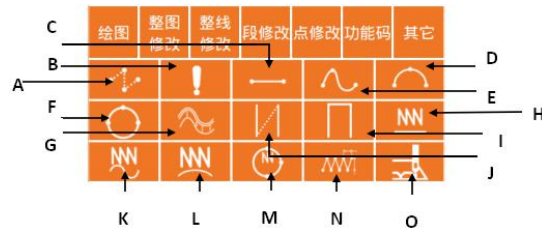

2: The whole picture is modified: according to the whole picture modification button, the dynamic button display area displays the following function buttons:

- (A): Move the sewing point button
- (B): Modify the entire graphics stitch length
- (C): Move the second original point

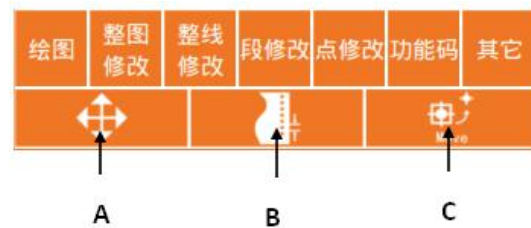

3: Complete line modification button: Press the entire line to modify the button. The dynamic button display area displays the following function buttons:

- (A): Modify the stitch length of the current line
- (B): Move the current line
- (C): Move the multiple lines
- (D): Copy the current line
- (E): Delete the current line
- (F): Move the current line and all the lines behind

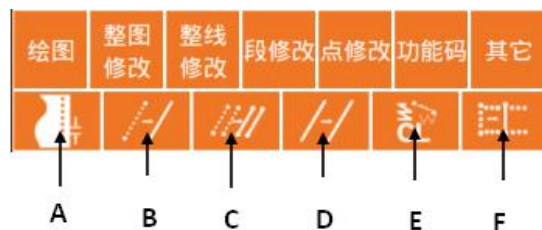

4: Segment modification button: Modify button by segment The dynamic button display area displays the following function buttons:

- (A):Section movement
- (B):Section modification
- (C):Section deletion

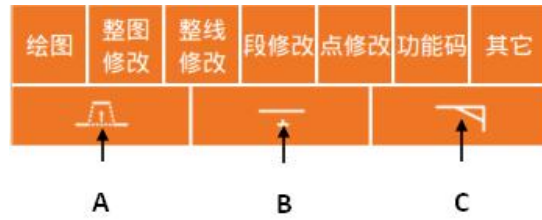

5: Click the Modify button: Press the Point Modify button. The Dynamic Button display area displays the following function buttons:

- (A):Moving point
- (B):Add point
- (C):Delete point

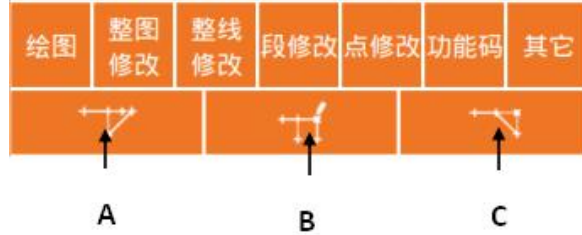

6: Function code button: Press the function code button. The dynamic button display area displays the following function buttons:

- (A):Cutting line
- (B):The second original point
- (C): Stop halfway
- (D):Line tension reference value
- (E):Medium presser foot height reference value
- (F): Wire tension
- (G):Middle presser foot height
- (H):Delete function code
- (I): Sewing speed
- (J): Jump speed
- (K):Machine stop
- (L): External input
- (M):External output
- (N):Edit function code
- (O): Side sliding device, flip-flop device and other dedicated expansion devices.

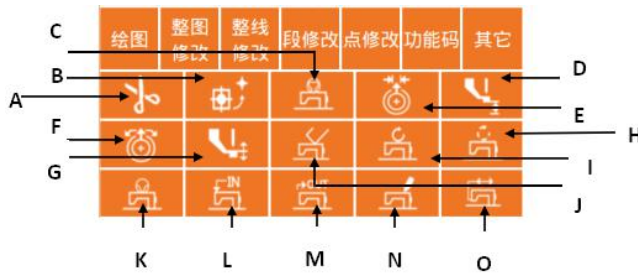

7: Other: Press other buttons. The dynamic button display area displays the following function buttons:

(A): Move to the specified needle

(B): Replace template function

(C): Move the jump



5.4 Exit pattern editing mode

Under the standard editing standard interface, press this button  to enter the mode choosing interface, as shown on the right.



6 Information function

6.1 View version information

1 Display information interface

In the data input interface, after pressing the information button (A) as shown on the right, the information interface is displayed.



2 Display the version interface.

Please press the version button of the information interface, and the version interface will be displayed. On the version interface, you can view the version information.



7 Communication function

The communication function completes the following functions:

Copying the sewing data compiled by other sewing machine or pattern making software to the operation panel through the USB flash drive;

Copy the sewing data in the operation panel to the USB flash drive.

7.1 About data that can be processed

The sewing data that can be processed is as follows:

Data Type	Standard format
VDT	VD00[0-9][0-9][1-9].VDT
sew	ISMS0[0-9][0-9][1-9].sew

7.2 Pattern transmission

1. Copy the pattern file from the USB flash drive to the operation panel

In the data input interface, after pressing the

communication button , The

communication interface is displayed, as shown on the right.

- 1) Press  this button, it means copy the pattern file from the USB flash drive to the operation panel:

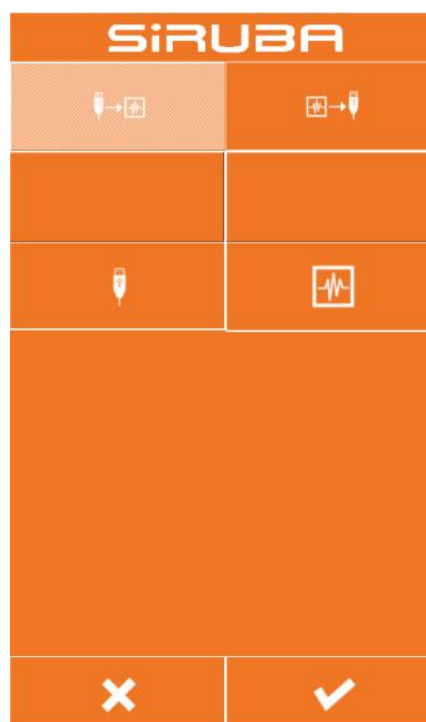

2) Press this button , it shows choose USB files interface, as shown on the right. Find the file you need to copy and press confirm

button.



3) Press the panel button , The input file number interface is displayed, as shown on the right. This file number is the file number after the file is copied to the operation panel. Press the OK button after entering the file

number.



4) After selecting the file from the USB flash drive and entering the operation panel file number, as shown on the right. Press the

confirm button , This will copy the files from the USB flash drive to the operation panel.

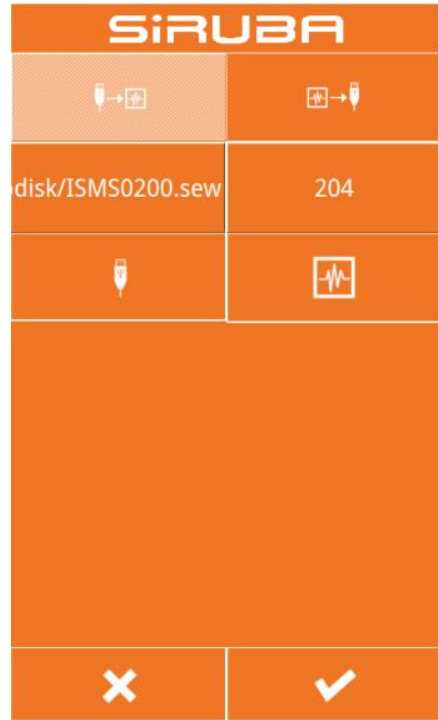



2.This will copy the files from the USB flash drive to the operation panel.

In the data input interface, after pressing the communication button, the communication interface is displayed, as shown in the right



figure. 

1) Select the button , this button means to copy the pattern file from the operation panel to the USB flash drive;

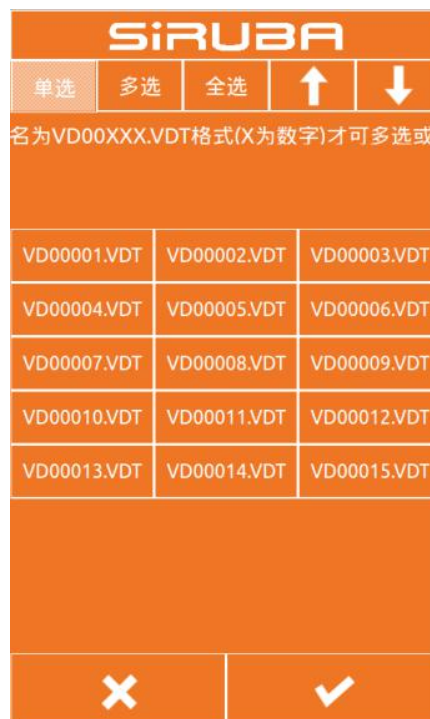

2) Press the panel button  , The screen for selecting the operation panel file is displayed, as shown on the right. Find the file you want to copy and press the OK button .



3) Press USB button  ,The input file number interface is displayed, as shown on the right. This file number is the file number after the file is copied to the U disk. After inputting the file number, press the OK button. .



4)After selecting the file from the operation panel and inputting the U disk file number, as shown on the right.Press confirm

button  , This will copy the files in the operation panel to the USB flash drive.



8 Mode and parameter settings

8.1 Mode switching

Press the normal sewing interface



to enter the setting interface (as

shown on the right), in which mode switching and setting can be performed.

Three modes: normal seam mode, pattern pattern, and loop stitch mode.

Sewing Mode

Press the normal sewing button to enter the normal sewing interface and switch to the normal sewing mode.

Design Pattern Mode

Press the pattern play button to enter the pattern making interface, switch to the pattern-making mode, and you can draw the picture, edit the pattern, modify the pattern, etc. in the pattern-making interface.

Circle Sewing Mode

Press the cycle sewing button to enter the cycle sewing interface and switch to the cycle mode.

SIRUBA	
普通缝	参数设置
花样打版	辅助功能
循环缝	计数器
测试	关于

8.2 Test

Press the test button to enter the test interface, as shown on the right.



8.2.1 Input test

Press the input test button to enter the input test interface. As shown in the figure on the right, you can check the X origin, Y origin, pedal switch, emergency stop switch, and disconnection detection status.



8.2.2 Action test

Press the action test button to enter the action test interface, as shown on the right. It is possible to test the X-axis movement action, the Y-axis movement action, the trimming action, the intermediate presser action, and the threading action.

 : X axis movement key

 : Y axis movement key

 : Trimming key

 : Presser foot key

 : Thread wipper key

 : Tensioner key

 : Trimming key

Select the action key to be tested, then click the plus button and minus button. If the corresponding machine component has an action, the action can be executed normally,

and press the button  to close the test.

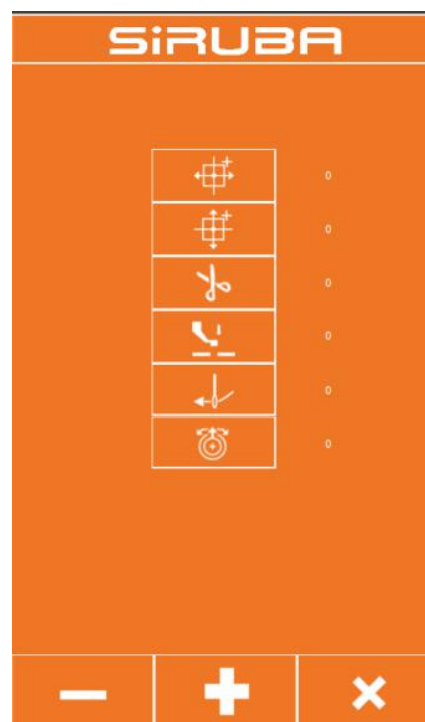

8.2.3 Output test

Press the output test button to enter the output test interface. As shown in the figure, after selecting the output port, press the plus or minus button. If the valve of the corresponding output port has action, the output port can work normally. After the test is

completed, press the button to close .

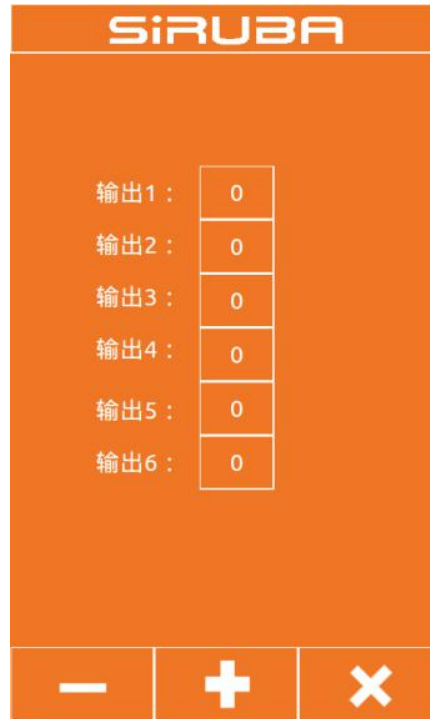

8.2.4 External output test

Press the external output test button to enter the external output test interface. As shown in the figure, after selecting the external output port, press the plus and minus keys. If the corresponding external output port of the expansion board has an action, the external output port can be Normal work, press the button to close the test after the test is

completed.

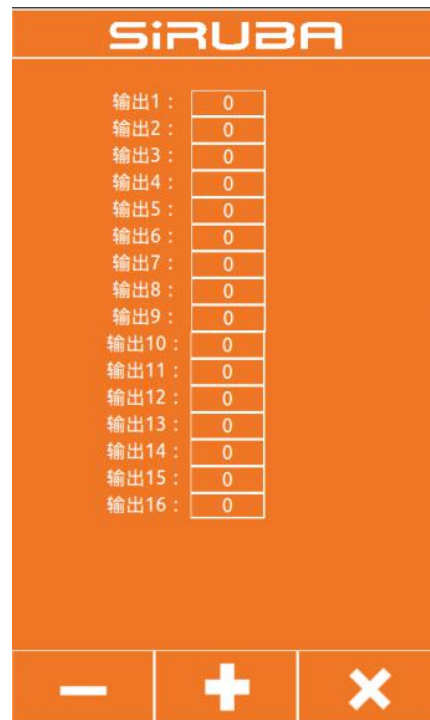

8.2.5 Spindle angle test

Press the spindle angle test button to enter the spindle angle test interface. As shown in the figure below, you can view the current spindle angle and rotate the spindle of the machine. The spindle angle will change with the rotation.



8.2.6 Simulate pedal calibration

Press the input test button to enter the input test interface. As shown in the figure on the right, click button A to enter the analog pedal calibration interface.

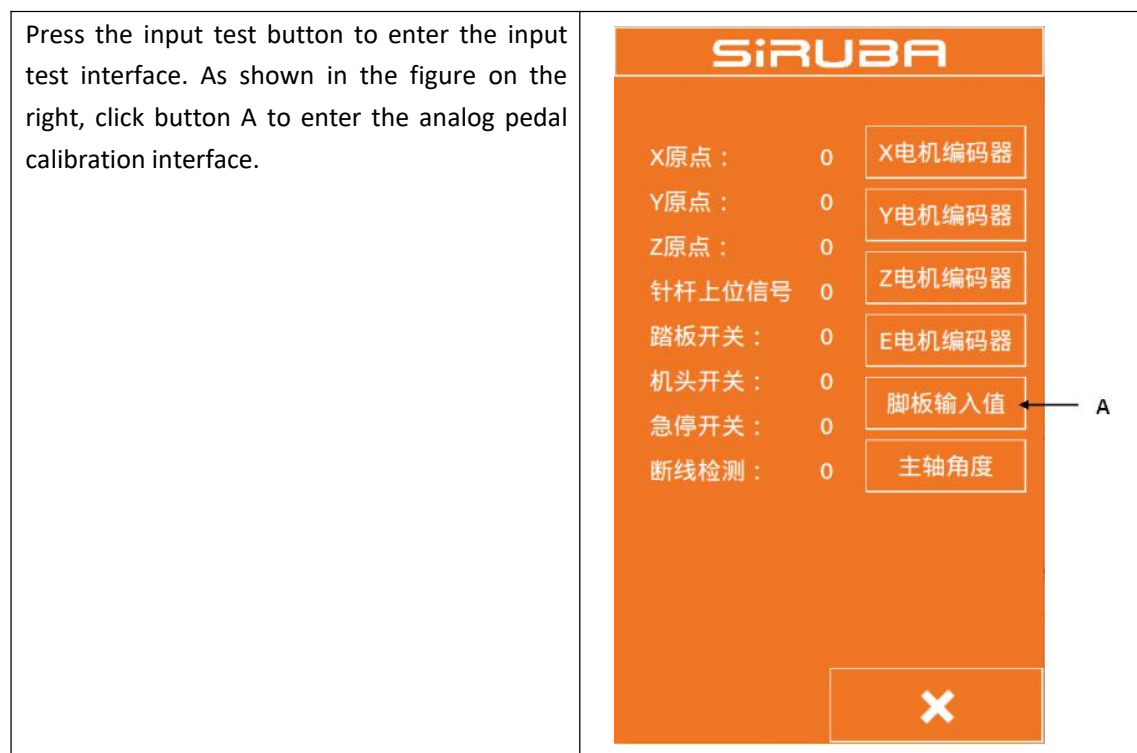

The analog pedal calibration interface is shown on the right.

B: Current pedal pedaling amount

C: The maximum amount of pedals to step on

D: Release the balance position of the pedal

E: The pedal is stepped on by the maximum amount.

Pedal calibration method:

1. Press button C to make it pressed, press the pedal to the maximum amount, press to save the current pedal input value;
2. Press button D to put the button in the pressed state, release the pedal to make the pedal in equilibrium, press again to save the current pedal input value;
3. Button E puts the button in the pressed state, and the pedal reverses the maximum value and presses again to save the current pedal input value.
4. After saving the three pedal input values, the pedal calibration completion button exits the current interface.

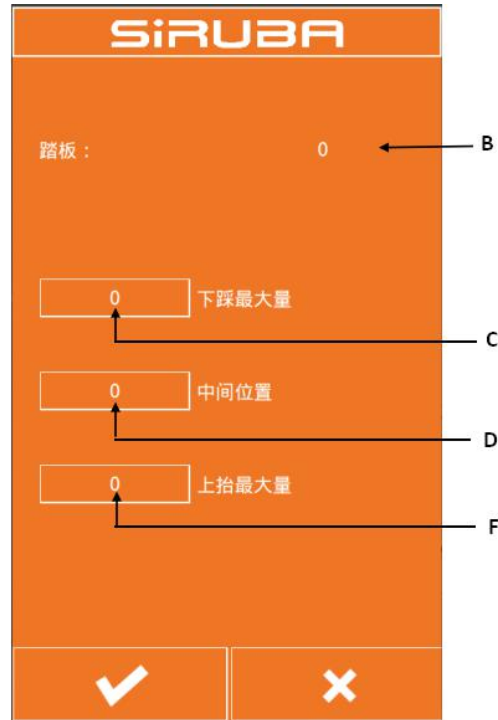

8.3 parameter settings

Click the parameter setting button to enter the parameter setting interface, as shown below. The main function of the parameter setting is the setting of some machine parameters and the setting of some options. Among the basic settings 1, some of the more commonly used settings are generally related to the control panel. The settings in the basic settings 2 are generally independent of the control panel. They are only related to the panel. In the advanced settings, some of the more important settings are required. Users with advanced permissions are required. You can set it by entering a password. Super settings are generally only available to factory technicians with super privileges.





8.3.1 Basic setting 1

Click the enter button in the basic setting 1 to enter the common basic parameter setting

interface, as shown below, through 

 Press the key to page forward and backward, select the parameter button that

needs to be changed, and pass  Key can query the details of the selected parameter

and then pass   The key can adjust the value of the parameter, click after

setting the parameter value  Key to ensure that the changes take effect, click the

 button to exit the common basic

parameter setting interface. 

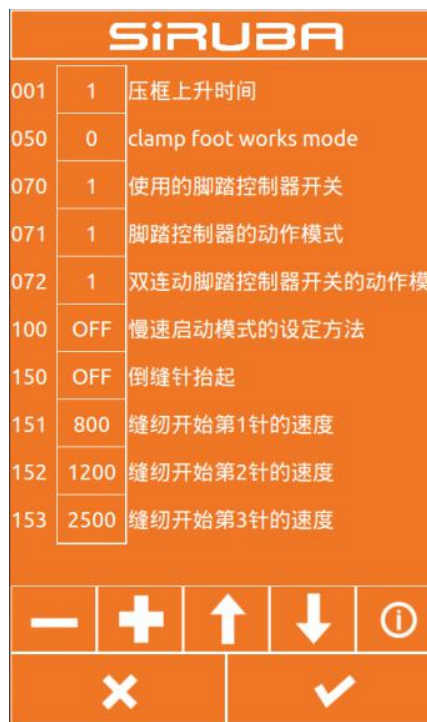

The basic settings 1 parameters are described in the following table:

No.	Predetermined area	Initial value	Setting unit	Setting content
1	OFF/1/2	1	-	Frame rise time: After the sewing is completed, the frame rise time OFF: Does not automatically rise 1: rise at the last needle position 2: Move to the beginning of sewing and rise
54	0~2	0	1	Dropping time of intermittent presser foot: 0: Linked down by the presser foot switch, but does not drop in the feed retraction position 1: Linked down by the presser foot switch 2: The presser foot switch is not linked, and the sewing starts to decrease.

70	1~2	1	1	Foot controller switch used 1: foot controller switch (single step) 2: Double linkage foot controller switch (optional)
71	1~2	2	1	1: secondary presser foot is invalid 2: The secondary presser foot is valid
150	ON / OFF	OFF	-	Reverse needle lift ON: The motor reverses when the upper shaft stops, and the needle bar returns to the uppermost position. [note] When the reverse needle is lifted, the thread take-up lever will rise when the thread take-up will stop at a lower position than usual. Therefore, there is a case where the needle is removed under each sewing condition. OFF: Invalid
151	200~2800 (sti/min)	400	100	The speed at which the sewing starts the first stitch
152	200~2800 (sti/min)	800	100	The speed at which the sewing starts the second stitch
153	200~2800 (sti/min)	1200	100	The speed at which the sewing starts the third stitch
154	200~2800 (sti/min)	1500	100	The speed at which the sewing starts the fourth stitch
155	200~2800 (sti/min)	2000	100	The speed at which the sewing starts the fifth stitch
156	400~2800 (sti/min)	2800	100	The speed at which the sewing starts the fifth stitch
157	400~2800 (sti/min)	2800	100	The speed at which the sewing starts the fifth stitch
158	400~2800 (sti/min)	2800	100	The speed at which the sewing starts the third stitch
159	400~2800 (sti/min)	2400	100	The speed at which the sewing starts the second stitch
163	1200~3200 (sti/min)	2700	100	Sewing speed limit
164	ON / OFF	OFF	-	Prohibit trimming action ON: All trimming actions are invalid OFF: Match the sewing data and

				trim the thread
462	0~2	0	1	Expand the narrowed reference point 0: Center of the sewing frame (origin) 1: sewing start point 2: pattern center point
471	1~17	14	1	Height of presser foot/button clamp (Electric presser foot only)
472	1~17	6	1	Two-stage presser setting: Set the height of the secondary presser foot in mm.
500	ON/OFF	1	-	Bottom line clamping function setting ON: valid OFF: Invalid
551	OFF/1~3	OFF	-	Sewing start line tension opening OFF: off 1~3: Open within the specified number of stitches
566	ON/OFF	OFF	-	Whether the bottom thread clamping device is installed ON: The bottom thread clamping device is installed OFF: The bottom thread clamping device is not installed. [note] Do not select OFF when installing the bobbin thread clamp. It is easy to cause damage to the device.
962	ON/OFF	OFF	-	Wire break detection ON: effective OFF: Invalid
963	0~1	0	1	0: manual tensioner 1: electronic tensioner
964	ON/OFF	OFF	-	Automatic running ON: valid OFF: Invalid
965	ON/OFF	OFF	-	Manual gripper opens ON: valid OFF: Invalid
966	0~2	2	1	Dialing method: 0: invalid

				1: electronic 2: Pneumatic.
992	0~1	0	1	Frame shifting 0: Move to the seam point after sewing is completed 1: Move to the specified point after sewing is completed
996	OFF/ON	OFF	-	OFF: Electric presser foot ON: pneumatic presser foot
997	0~2	0	1	0: The left and right presser feet are simultaneously dropped 1: first left and right drop foot 2: first right rear left drop foot (The valve foot is the left and right pressure foot and is operated by double pedal)
1000	0~1	0	1	Professional setting 0: invalid 5: ready signal 6: Automatic ready signal

8.3.2 Basic setting 2

1. Basic settings 2 interface

Click the Enter button in Basic Settings 2 to enter the Basic Settings 2 screen as shown.

2. Basic settings 2 function description

1) Restore the super password

If you have forgotten your super password, you can use the recovery super password as the default password. Using this feature requires a password from us to get recovery privileges.

2) Time and date settings

Set the current date and time.

3) Host computer parameter setting

Press the host computer parameter setting button to enter the host computer parameter setting interface, as shown in the figure below.



(1) Beep: ON: Use the beep, OFF: Turn off the beep.

(2) The prompt tone uses the default tone: ON: the prompt tone uses the unified default tone, and the OFF: prompt tone does not use the unified default tone.

(3) Prompt tone type: Select the type of default beep.

(4) Stitch display: ON: The stitch point is displayed in all states in the pattern; OFF: The stitch point is displayed when the stitch point is operated in the pattern.

(5) Power type: Select pneumatic or electric depending on the type of machine power.



8.3.3 Advanced Settings

8.3.3.1 Advanced settings interface

Click the blank space after the password to enter the password. After entering the password, click the Enter button to enter the advanced settings interface, as shown in the figure below. The password setting button can change the password for entering the advanced settings. The parameter setting button can set some advanced parameters. The upper computer upgrade button can upgrade the panel program. The lower computer upgrade button can upgrade the control board program. The factory reset button can restore some parameters of the program to the factory settings. The origin adjustment button can adjust the origin position.



8.3.3.2 Advanced setting parameters

Click the parameter setting button to enter the advanced parameter setting interface as shown.

- (1) Language selection: set Chinese and English.
- (2) Template machine status: OFF: The template auto-sensing function is not used; ON: The template auto-sensing function is used.
- (3) Template detection: The default is set to OFF. If it is set to ON, the template will leave an error when the template leaves the template sensor.
- (4) Template position sensor: The default setting is OFF. If it is set to ON, the template leaves the template sensor and the machine does not work.
- (5) Head memory: The organic head memory needs to be set to ON.
- (6) Trimming angle adjustment: Negative value



is advanced, positive value is delay (-60 to 30).

(7) Feeding time adjustment: Negative value is advanced, positive value is delay (-60 to 30).

(8) Number of needle detection needles: Set the sensitivity of the thread detection needle count.

(9) Empty feed speed: Set the air feed speed grade (1-10), the larger the value, the faster.

(10) Needle angle adjustment: Set the spindle stop angle.

8.3.3.3 Host computer upgrade

This program can upgrade the host computer (panel) through the U disk. Before upgrading, you need to copy the new version of the program panel file and the qm folder to the U disk main directory, then insert the U disk into the panel, and then set the parameters --- >Advanced Settings--->Upper computer upgrades to upgrade the panel program. After the upgrade is successful, the message "Success, please restart" will appear, restart.





8.3.3.4 Lower machine upgrade

This program can upgrade the lower computer (control board) through U disk. Before upgrading, you need to copy the new version program (0806 model nc.bin file) (430F/438F model STNC430.BIN file) to the U disk main directory. Then insert the U disk into the panel, and then upgrade the control board program through parameter setting ---> advanced settings ---> lower computer upgrade. After the upgrade is successful, the message "Success, please restart" will appear, restart.

8.3.3.5 Resetting

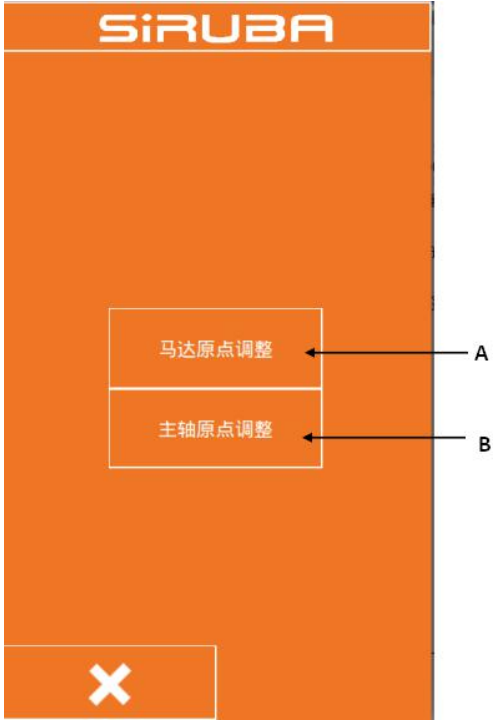
This program restores the parameters in Basic Setting 1 to the default values by restoring the factory settings.

8.3.3.6 Origin adjustment

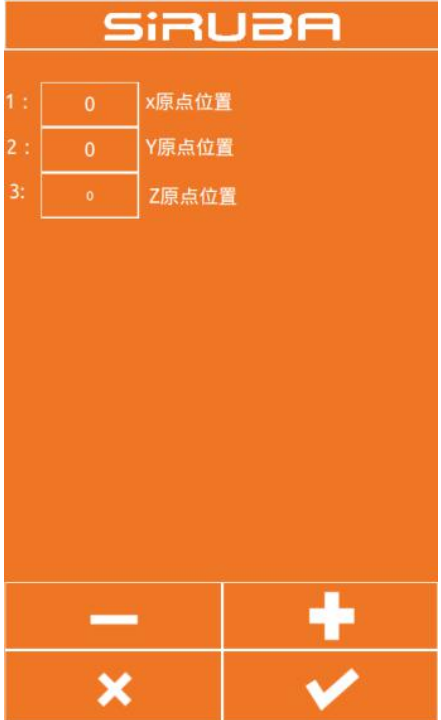
<p>Click the origin adjustment button to enter the origin adjustment interface as shown.</p>	
<p>1.Motor origin adjustment</p> <p>Press the A button to enter the motor home position adjustment interface, as shown in the figure, press the 1/2/3 button (to make the button pressed), press  、  The key can adjust the origin position of the X/Y/Z motor, and click after the adjustment is completed.  (The button is pressed to be lifted), save the current adjustment value, click  Press to exit.</p>	

2.Press to exit

Press the B button to enter the spindle origin adjustment interface as shown.

C: current spindle angle display value

(If the displayed value is 65535 or -1, turn the spindle in the direction of the handwheel arrow until the value between 0 and 360 is displayed)

D: parking angle value stored in the head memory

Spindle origin adjustment method: When the spindle display value is between 0 and 360 in the direction of the arrow of the handwheel, stop the needle bar at the stop position and press the D button (to make the button

pressed). Press  Press the button to save the value displayed in the current C position, that is, the spindle parking position,

press  The key exits.

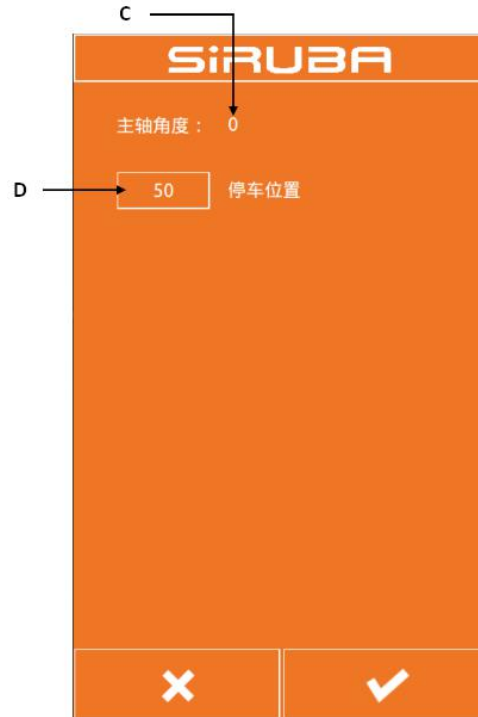

8.3.4 Super setting

8.3.4.1 Super settings interface

The super setting interface is shown in the figure and set by the manufacturer. Users cannot change it at will. Generally, the parameters in the super setting need to be set before leaving the factory.



8.3.4.2 Super setting parameter

Click the parameter setting button to enter the parameter setting interface of the super parameter, as shown in the figure.

- (1) Machine type: Select the appropriate model according to the machine type.
- (2) Display style: Generally choose the default style.
- (3) Sewing speed limit value: Set the sewing speed maximum value, and the sewing speed will not exceed this value after setting.



8.3.4.3 Installment setting

Press the installment payment button to enter the installment payment interface. Enter the installment payment interface and enter the password to proceed to the next step. For the password, please contact the manufacturer. After entering the password, you can set the panel ID number. After setting the ID number, the machine cannot be sewn. You need to enter the installment password in the advanced settings to sew. Please contact the factory for the installment payment password.

8.4 Accessibility

Press the auxiliary function key to enter the auxiliary function interface as shown.



8.4.1. Template ID

This function is used to define the template. The template has a wireless identification card. Each card has an ID number, which corresponds to the P pattern number in the panel. When a new wireless identification card template is created or the template ID is changed, the wireless identification card is placed on the template sensor, and then the template ID number is entered in the template ID edit box of the auxiliary function interface, and the "write" is clicked after the input is completed. The button can be used to write the template ID number to the wireless identification card, and the completion of the write will be successful.

8.4.2. Change startup image

If you want to change the image displayed when the panel is started, you can send the image you want to display to us, then we will change the image to a file of the specified format and send it to you. You will put the modified image file on the USB flash drive. Insert the USB flash drive into the panel, you can click the “Change” button to change the startup image, and the change will complete the prompt.

8.4.3. Kernel upgrade

When you need to upgrade the kernel, we will provide you with the conprog.bin file. You can put this file into the USB flash drive and insert the USB flash drive into the panel. After the panel recognizes the USB flash drive, you can click on the kernel upgrade. The button is upgraded. After the upgrade is completed, the upgrade will be prompted.

8.4.4. Tone tone upgrade

When you need to upgrade the button prompt tone, we will provide the wxaudio folder for you. You put this folder into the USB flash drive and insert the USB flash drive into the panel. After the panel recognizes the USB flash drive, you can click " The prompt tone upgrade button will be upgraded. After the upgrade is completed, the upgrade will be prompted.

8.5 counter

Press the counter button to enter the counter interface, as shown on the right. The sewing counter and the stitch counter mode can be set to set the counter current value and maximum value.

加计数器	0	1000
缝制计数器模式	当前值	最大值
减计数器	10000	10000
针数计数器模式	当前值	最大值

8.6 Regarding

Press the About button to enter the copyright information inquiry interface, enter the password to view the copyright information.

9. Appendix 1 Error Table

In the event of a machine failure, the operator panel will display an error code.

Please follow the trouble shooting methods in the table below to troubleshoot.

error code	description
10	The emergency stop switch was smashed.press RESET button to eliminate errors.
11	Press Pause the switch.press RESET button to eliminate errors.press Move the presser foot after this key to continue sewing.
12	Press Pause the switch.press After the RESET button is used to cancel the error, step the pedal to the 2nd step and check the origin.
15	When the power is turned on, the emergency stop switch is turned off, but the emergency stop switch is in poor contact. Turn off the power and check the plug of the motherboard socket P9.
16	Poor contact in the emergency stop switch when the power is turned on. Turn off the power and check the plug of the motherboard socket P9.
25	When the power is turned on, the foot pedal switch is stepped on the second gear position. (When the 2-foot pedal switch is the start switch) Turn off the power and check the foot pedal switch.
35	The foot pedal switch is stepped to the first gear position when the power is turned on. (When the 2-foot pedal switch is pressed, the power is turned off) and the foot pedal switch is confirmed.
50	After the power was turned on, the sewing machine head was found to be dumped. Turn off the power and lift the sewing machine head. Confirm the plug of the motherboard socket P14.
51	The sewing machine head was found to be dumped during the sewing machine start-up process. Turn off the power and check the plug of the motherboard socket P14.
55	When the power was turned on, the sewing machine head was found to be dumped. Turn off the power and lift the sewing machine head. Turn off the power and check the plug of the motherboard socket P14.
65	When the power is turned on, the keys on the operation panel are in the state of being squatted, or the keys are not in good contact. Turn off the power and check the operation panel keys.
100	After the “GREASEUP” notification appears, if no grease is added (do not perform the cleaning operation). Add a run, and then perform the action of clearing the work.
111	Incorrect parking position---Turn off the power and check if the thread trimming device or the sewing machine motor is abnormal.
121	Trimming cannot be completed. Turn off the power and check if the blade of the fixed knife or moving knife is scratched or damaged.
130	Main motor failure --- spindle motor failure, or spindle motor controller failure.
131	Poor contact in the sync display. Turn off the power and check that the plug of the motor board's main board P11 is in good condition.
132	It is found that the main motor of the sewing machine is abnormally rotated to cut off the power supply, and it is confirmed that the plug of the motor board main board P11 is in

	good condition.
133	The sewing main motor stops at a bad position. Turn off the power and check that the plug of the motor board's main board P11 is in good condition.
150	The main motor of the sewing machine is abnormally warmed up or the temperature sensor is not working properly. Turn off the power and check the condition of the sewing machine motor. (If the sewing data is stitched (short cycle) with the number of short stitches (15 stitches) repeatedly, if the upper shaft motor overheats, [E150] may occur.)
200	The origin cannot be found in the X direction --- X motor failure, or Y origin sensor failure
201	The X pulse motor stops abnormally. Turn off the power and check if there is any abnormality in the X feed direction.
203	X motor over current --- X motor failure, or X motor control board failure
204	During the sewing process, the X pulse motor stops abnormally. Turn off the power and check if there is any abnormality in the X feed direction.
205	The X pulse motor stops abnormally during the movement to the sewing start position. Turn off the power and check if there is any abnormality in the X feed direction.
206	During the test transfer, the X pulse motor stops abnormally. Turn off the power and check if there is any abnormality in the X feed direction.
207	Unable to detect X motor motion---Y motor failure, or X motor encoder failure, or X motor control board failure
208	X motor out of control --- X motor encoder failure, or X motor control board failure
210	Y direction can not find the origin - Y motor failure, or Y origin sensor failure
211	The Y pulse motor stops abnormally. Turn off the power and check if there is any abnormality in the Y feed direction.
213	Y motor over current --- Y motor failure, or Y motor control board failure
214	During the sewing process, the Y pulse motor stops abnormally. Turn off the power and check if there is any abnormality in the Y feed direction.
215	The Y pulse motor stops abnormally during the movement to the sewing start position. Turn off the power and check if there is any abnormality in the Y feed direction.
216	During the test transfer, the Y pulse motor stops abnormally. Turn off the power and check if there is any abnormality in the Y feed direction.
217	Unable to detect Y motor motion---Y motor fault, or Y motor encoder fault, or Y motor control board fault
218	Y motor out of control---Y motor encoder failure, or Y motor control board failure
300	The trimming motor can't find the origin---trimming motor fault, or the trimming motor encoder is faulty.
301	It is not possible to detect the rise and fall of the presser foot/button clamp. Turn off the power and check if there is any abnormality in the up and down direction of the presser foot/button clamp.
303	Trimming motor overcurrent---trimming motor failure, or trimming motor control board failure
307	Unable to detect electric motion of trimming motor---trimming motor fault, or trimming motor encoder fault, or trimming motor control board fault
308	The trimming motor is out of control---the trimming motor encoder is faulty, or the

	trimming motor control board is faulty.
320	The wire grabbing motor can't find the origin - catch the wire motor fault, or catch the wire motor encoder fault
321	Catch the line motor over current --- catch the line motor failure, or catch the line motor control board failure
323	Unable to detect the electric movement of the wire grab motor---catch the motor fault, or catch the line motor encoder fault, or catch the line motor control board fault
324	The line grab motor is out of control---catch the line motor encoder failure, or the line grab motor control board is faulty.
400	When the power is connected, the connection communication error between the main board and the main board of the control board is detected. Turn off the power and check that the socket P1 of the control board main board and the socket P3 of the motor main board are in good condition.
401	When the power is connected, the link communication error between the main board and the motor main board is detected. Turn off the power and check that the plug P5 of the main board and the plug P2 of the motor main board are in good condition.
410	A communication error between the main board and the main board of the control board was detected. Turn off the power and plug it in again.
411	A communication error has been detected between the motherboard and the motor board. Turn off the power and plug it in again.
420	The storage tool is not inserted. Press RESET button to eliminate errors.
421	The data content is incorrect and cannot be used, or there is no data. press RESET button to eliminate errors. Confirm whether the data of the model serial number is stored in the storage tool.
422	An error occurred while reading the storage tool information. Press RESET button to eliminate errors. Confirm the data in the storage tool.
424	There is not enough space in the storage tool. press RESET button to eliminate errors. Use other storage tools.
425	An error occurred while writing to the storage tool. Press RESET button to eliminate errors. Please use the specified storage tool. Check if writing is prohibited or if there is room.
427	The style registered in the loop program is deleted. press RESET button to eliminate errors. Re-register the loop program and add the style.
428	The style set in the program is deleted. press RESET button to eliminate errors. Reset the program and add a pattern.
430	Data cannot be backed up to the motherboard. Turn off the power and reconnect the power.
440	The CPU PCB data storage is abnormal. Turn off the power and reconnect the power.
450	The model selection information cannot be read from the head storage device. Turn off the power and check that the plug of the power supply main board P16 is in good condition.
451	Data cannot be stored in the head memory. Turn off the power and reconnect the power.
452	Unable to connect to the head storage device. Turn off the power and check if the plug of the main board's P16 is in good condition.
480	Template position sensor exception

500	After making the enlarged setting, the sewing data exceeds the area where sewing is possible. press RESET button to eliminate errors. Set the magnification or sewing area again.
502	After making the enlarged setting, the data pitch exceeds the maximum pitch of 12.7 mm.press RESET button to eliminate errors. Set the magnification again.
510	The program data is abnormal.press RESET button to eliminate errors. Re-read program data from the storage tool or re-program the data.
511	The completion code cannot be entered into the program data. Press RESET button to eliminate errors. Redo the program data of the input completion code, or change the serial number of the read program.
512	More than the number of stitches that can be used.press RESET button to eliminate errors. Change the serial number of the reader.
581	The storage switch folder could not be read correctly. The model before copying and the model after copying are incorrect. (The data of 438F has the possibility of reading to 430F) press RESET button to eliminate the error. Please read the data of the same model.
582	The versions of the memory switches are inconsistent. Press RESET button to eliminate errors. Please read the same version of the data.
583	The version of the parameter does not match. Press RESET button to eliminate errors. Please read the same version of the data.
600	A facial line break occurred. press RESET button to eliminate errors. Move the KEY_STEP_BACK button moves the presser foot to continue sewing.
690	The medium-pressure foot motor cannot find the origin---the medium-pressure foot motor is faulty, or the medium-pressure foot motor encoder is faulty.
691	The bottom thread clamping motor stops abnormally. Check if the excess line is too long. Turn off the power and remove the flying velvet at the bottom of the needle plate. Check if the plugs of the sockets P20 and P4 of the main board are in good condition.
693	Intermediate presser motor overcurrent---Medium presser foot motor failure, or medium presser foot motor control board failure
697	Cannot detect the electric motion of the medium-pressure foot motor---the medium-pressure foot motor is faulty, or the medium-pressure foot motor encoder is faulty, or the medium-pressure foot motor control board is faulty.
698	The medium-pressure foot motor is out of control---the medium-pressure foot motor encoder is faulty, or the medium-pressure foot motor control board is faulty.
700	The power supply voltage has risen abnormally. Turn off the power and check the input voltage.
701	The main motor drive voltage of the sewing machine has risen abnormally. Turn off the power and confirm the voltage
705	The power supply voltage drops abnormally. Turn off the power and check the input voltage.
710	The sewing main motor detects an abnormal current. Turn off the power and check if the sewing machine is abnormal.
711	The pulse motor detects an abnormal current. Turn off the power and check if the presser/button clamp is operating abnormally.
720	The head cannot be down
721	The head cannot be raised
820	Pattern queue empty

821	Pattern no end code
822	No stop code
830	Pattern data overflow
850	CAN bus response error
901	X motor pulse error (internal error)
902	Y motor pulse error (internal error)
903	Trimming motor pulse error (internal error)
904	Middle presser motor pulse error (internal error)
905	Traction motor pulse error (internal error)
906	internal error
911	internal error
912	internal error
913	internal error
914	internal error