

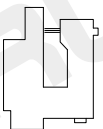



筒車規格件表 / CONVERSION CHART

P1

機型	規格	針座	針板	主送具	差送具	押具	上叉	勾針	針號
									
MODEL	SUB-CLASS	NEEDLE CLAMP	NEEDLE PLATE	MAIN FEED DOG	DIFF. FEED DOG	PRESSER FOOT	SPREADER	LOOPER	NEEDLE
機型	規格	針座	針板	主送具	差送具	押具	上叉	勾針	針號
C007J-W121 C858J /CH	356 364	M5356 M5364	E3816P E3817P	D4206 D4207	H4458 H4459	P2446-A P2447-A	MH41	MT01	YXX128GAS #10
C007J-W121 C858J /CH	356 364	M5356 M5364	E3816P E3817P	D4206 D4207	H4458 H4459	P2446-A P2447-A	—	MT01	YXX128GAS #10
C007J-W121 C858J /CH	356 364	M5356 M5364	E3816P E3817P	D4206 D4207	H4458 H4459	P2446-A P2447-A	—	MT01	YXX128GAS #10
C007J-W122 C858J /CH	240 248 256 356 364	M5240 M5248 M5356 M5356 M5364	E3524P E3525P E3826S E3826P E3827P	D4206 D4206 D4206 D4206 D4207	H4458 H4458 H4458 H4458 H4459	P2544-A P2545-A P2446-A P2446-A P2447-A	MH41	MT01	YXX128GAS #10
C007J-W122 C858J /CH	240 248 256 356 364	M5240 M5248 M5356 M5356 M5364	E3524P E3525P E3826S E3826P E3827P	D4206 D4206 D4206 D4206 D4207	H4458 H4458 H4458 H4458 H4459	P2544-A P2545-A P2446-A P2446-A P2447-A	—	MT01	YXX128GAS #10
C007J-W122 C858J /CH	240 248 256 356 364	M5240 M5248 M5356 M5356 M5364	E3524P E3525P E3826S E3826P E3827P	D4206 D4206 D4206 D4206 D4207	H4458 H4458 H4458 H4458 H4459	P2544-A P2545-A P2446-A P2446-A P2447-A	MH41	MT01	YXX128GAS #10

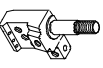
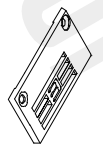
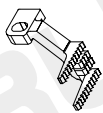
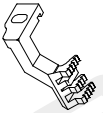
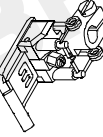
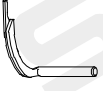
註：P2544-A/P2545-A為固定式押具舌，亦可使用活動式押具舌 P2565-A代替 P2544-A/P2545-A

P2544-A/P2545-A is the fixed presser foot tongue. It can be replaced by the removable presser foot tongue P2565-A.

P2446-A/P2447-A為固定式押具舌，亦可使用活動式押具舌 P2466-A代替 P2446-A/P2447-A

P2446-A/P2447-A is the fixed presser tongue. It can be replaced by the removable presser foot tongue P2466-A.

筒車規格件表 / CONVERSION CHART

P2

機型 MODEL	規格 SUB-CLASS	針座 NEEDLE CLAMP	針板 NEEDLE PLATE	主送具 MAIN FEED DOG	差送具 DIFF. FEED DOG	押具 PRESSER FOOT	上叉 SPREADER	勾針 LOOPER	針號 NEEDLE
C007J-U122 C858J /CH/UTQ(UTS)	240	M5240	E3524P	D4206	H4458	P2544-A	—	MT01	UYX128GAS #10
	248	M5248	E3525P	D4206	H4458	P2545-A			
	256	M5356	E3826S	D4206	H4458	P2446-A			
C007J-W122 C858J /CHA	356	M5364	E3826P	D4206	H4459	P2447-A	—	MT01	UYX128GAS #10
	356	M5356	E3826Q	D4206	H4458	P0216-A			
	356	M5364	E3827P	D4207	H4459	P2447-A			
C007J-U122 C858J /CHA	356	M5356	E3826Q	D4206	H4458	P0416-A	—	MT01	UYX128GAS #10
	240	M5240	E3534P	D4206	H4458	P2544-A			
	248	M5248	E3535P	D4206	H4458	P2545-A			
C007J-W123 C858J /CH	356	M5356	E3836P	D4206	H4458	P2446-A	MH41	MT01	UYX128GAS #10
	364	M5364	E3837P	D4207	H4459	P2447-A			
	240	M5240	E3534P	D4206	H4458	P2544-A			
C007J-U123 C858J /CH	248	M5248	E3535P	D4206	H4458	P2545-A	—	MT01	UYX128GAS #10
	356	M5356	E3836P	D4206	H4458	P2446-A			
	364	M5364	E3837P	D4207	H4459	P2447-A			
C007J-W132 C858J /CHE/UTP(UTR)	240	M5240	E2324P	D2109	H2219	P2904-A	MH41	MT01	UYX128GAS #10
	248	M5248	E2325P	D2109	H2219	P2905-A			
	356	M5356	E2326P	D2110	H2220	P2906-A			
C007J-W132 C858J /CHE/UTP(UTR)	364	M5364	E2327P	D2110	H2220	P2907-A	MH41	MT01	UYX128GAS #10
	356	M5356	E2326P	D2110	H2220	P2907-A			
	364	M5364	E2327P	D2110	H2220	P2907-A			

註：P2544-A/P2545-A為固定式押具舌，亦可使用活動式押具舌 P2565-A代替P2544-A/P2545-A
 P2544-A/P2545-A is the fixed presser foot tongue. It can be replaced by the removable presser foot tongue P2565-A.
 P2446-A/P2447-A為固定式押具舌，亦可使用活動式押具舌 P2466-A代替P2446-A/P2447-A
 P2446-A/P2447-A is the fixed presser tongue. It can be replaced by the removable presser foot tongue P2466-A.

筒車規格件表 / CONVERSION CHART

P3

機 型	規 格	針 座	針 板	主送具	差送具	押 具	上 叉	勾 針	針 號
MODEL	SUB-CLASS	NEEDLE CLAMP	NEEDLE PLATE	MAIN FEED DOG	DIFF. FEED DOG	PRESSER FOOT	SPREADER	LOOPER	NEEDLE
C007J-W152 C858J /CZ/UTP/RLQ	356 364	M5356 M5364	E4326P E4327P	D3216 D3217	H3262 H3263	P2416-A P2417-A	MH41	MT01	UYX128GAS #10
C007J-U152 C858J /CZ/UTQ/RLQ	356 364	M5356 M5364	E4326P E4327P	D3216 D3217	H3262 H3263	P2416-A P2417-A	MH41	MT01	UYX128GAS #10
C007J-U152 C858J /CZ/CLA/UTP/RLQ	356 364	M5356 M5364	E4326P E4327P	D3216 D3217	H3262 H3263	P2416-A P2417-A	—	MT01	UYX128GAS #10
C007J-U152 C858J /CZ/CLA/UTQ/RLQ	356 364	M5356 M5364	E4326P E4327P	D3216 D3217	H3262 H3263	P2416-A P2417-A	—	MT01	UYX128GAS #10
C007J-W162 C858J	240 248 356 364	M5240 M5248 M5356 M5364	E3544 E3545 E3846 E3847	D4206 D4206 D4206 D4207	H4458 H4458 H4458 H4459	P2544-A P2545-A P2446-A P2447-A	—	MT01A	TVX5 #14~16
C007J-U162 C858J	240 248 356 364	M5240 M5248 M5356 M5364	E3544 E3545 E3846 E3847	D4206 D4206 D4206 D4207	H4458 H4458 H4458 H4459	P2544-A P2545-A P2446-A P2447-A	MH41	MT01A	TVX5 #14~16
C007J-U162 C858J /UTP (UTR)	240 248 356 364	M5240 M5248 M5356 M5364	E3544 E3545 E3846 E3847	D4206 D4206 D4206 D4207	H4458 H4458 H4458 H4459	P2544-A P2545-A P2446-A P2447-A	—	MT01A	TVX5 #14~16
C007J-U162 C858J /UTQ (UTS)	240 248 356 364	M5240 M5248 M5356 M5364	E3544 E3545 E3846 E3847	D4206 D4206 D4206 D4207	H4458 H4458 H4458 H4459	P2544-A P2545-A P2446-A P2447-A	—	MT01A	TVX5 #14~16

註：P2544-A/P2545-A為固定式押具舌，亦可使用活動式押具舌 P2565-A代替 P2544-A/P2545-A
 P2544-A/P2545-A is the fixed presser foot tongue. It can be replaced by the removable presser foot tongue P2565-A.
 P2446-A/P2447-A為固定式押具舌，亦可使用活動式押具舌 P2466-A代替 P2446-A/P2447-A
 P2446-A/P2447-A is the fixed presser tongue. It can be replaced by the removable presser foot tongue P2466-A.

09/12/11

簡單規格件表 / CONVERSION CHART

P4

MODEL	SUB-CLASS	NEEDLE CLAMP	NEEDLE PLATE	MAIN FEED DOG	DIFF. FEED DOG	PRESSER FOOT	SPREADER	LOOPER	NEEDLE
C007J-W222 C858J /CC	240	M5240	E4124P	D3216	H3362	P1814-A	MH41	MT01	UYX128GAS #10
	248	M5248	E4125P	D3216	H3362	P1815-A			
C007J-U222 C858J /CC	356	M5356	E4426P	D3216	H3362	P2116-A	—	—	UYX128GAS #10
	364	M5364	E4427P	D3217	H3363	P2117-A			
C007J-W222 C858J /CQA/CLA	256	M5356	E2326Q	D2110	H2220Q	P2906Q-A	MH41	MT01A	TVX5 #14
C007J-W322 C858J /CC	356	M5356	E2826P	D2107L	H3259M	P2456-A	MH41	MT01	UYX128GAS #10
	364	M5364	E2827P	D2107L	H3259M	P2457-A			
C007J-U322 C858J /CC	356	M5356	E2826P	D2107L	H3259M	P2456-A	—	MT01	UYX128GAS #10
	364	M5364	E2827P	D2107L	H3259M	P2457-A			
C007J-W322 C858J /CC/UTR(UTR)	356	M5356	E2826P	D2107L	H3259M	P2456-A	MH41	MT01	UYX128GAS #10
	364	M5364	E2827P	D2107L	H3259M	P2457-A			
C007J-U322 C858J /CC/UTQ(UTS)	356	M5356	E2826P	D2107L	H3259M	P2456-A	—	MT01	UYX128GAS #10
	364	M5364	E2827P	D2107L	H3259M	P2457-A			

註(1) : P2544-A/P2545-A為固定式押具舌,亦可使用活動式押具舌 P2565-A代替P2544-A/P2545-A
P2544-A/P2545-A is the fixed presser foot tongue. It can be replaced by the removable presser foot tongue P2565-A.

09/12/11

註(2) : C007J-W/U322A-356 /CC 時, 該針板與送具改用 C007J-W/U122-364 之針板與送具, 加附CHJ-A
When W/U322A-356 /CC, The needle plate and the feed dog have to be replaced by C007J-W/U122-364 needle plate and the feed dog, with CHJ-A attached.

註(2) : C007J-W/U322A-356 /CC 時, 該針板與送具改用 C007J-W/U122-364 之針板與送具, 加附CHJ-A
When W/U322A-356 /CC, The needle plate and the feed dog have to be replaced by C007J-W/U122-364 needle plate and the feed dog, with CHJ-A attached.

When W/U322A-356 /CC, The needle plate and the feed dog have to be replaced by C007J-W/U122-364 needle plate and the feed dog, with CHJ-A attached.

with CHJ-A attached.

筒車規格件表 / CONVERSION CHART

MODEL	SUB-CLASS	NEEDLE CLAMP	NEEDLE PLATE	MAIN FEED DOG	DIFF. FEED DOG	PRESSER FOOT	SPREADER	LOOPER	NEEDLE
機 型	規 格	針 座	針 板	主 送 具	差 送 具	押 具	上 叉	勾 針	針 號
C007J-C858J /CE	356 364	M5356 M5364	E2626P E2627P	D2107	H3159	P2456-A P2457-A	MH41	MT01	UYX128GAS #10
C007J-C858J /CE	356 364	M5356 M5364	E2626P E2627P	D2107	H3159	P2456-A P2457-A	—	MT01	UYX128GAS #10
C007J-C858J /CE/UTP(UTS)	356 364	M5356 M5364	E2626P E2627P	D2107	H3159	P2456-A P2457-A	—	MT01	UYX128GAS #10

註：P2544-A/P2545-A為固定式押具舌，亦可使用活動式押具舌 P2565-A代替P2544-A/P2545-A
 P2544-A/P2545-A is the fixed presser foot tongue. It can be replaced by the removable presser foot tongue P2565-A.
 P2446-A/P2447-A為固定式押具舌，亦可使用活動式押具舌 P2466-A代替P2446-A/P2447-A
 P2446-A/P2447-A is the fixed presser tongue. It can be replaced by the removable presser foot tongue P2466-A.

筒車規格件表 / CONVERSION CHART

機 型	規 格	針 座	針 板	主送具	差送具	押 具	上 叉	勾 針	針 號
MODEL	SUB-CLASS	NEEDLE CLAMP	NEEDLE PLATE	MAIN FEED DOG	DIFF. FEED DOG	PRESSER FOOT	SPREADER	LOOPER	NEEDLE
C007J -W512 C858J /FE(FFC)	232 240 356 364	M5232 M5240 M5356 M5364	E3523R E3524R E3826R E3827R	D4205 D4206 D4206 D4207	H4457 H4458 H4458 H4459	P2913-A P2914-A P3216-A P3217-A	MH41	MT01	UYX128GAS #10
C007J -U512 C858J /FE(FFC)	240 356 364	M5240 M5356 M5364	E3524R E3826R E3827R	D4206 D4206 D4207	H4458 H4458 H4459	P3414-A P3716-A P3717-A	—	MT01	UYX128GAS #10
C007J -W522 C858J /FE(FFC)/CR/CL	356 364	M5356 M5364	E6426R E6427R	D3222	H3268	P3816R-A P3817R-A	MH41	MT01	UYX128GAS #10
C007J -U522 C858J /FE(FFC)/CR/CL	356 364	M5356 M5364	E6426R E6427R	D3222	H3268	P3816R-A P3817R-A	—	MT01	UYX128GAS #10
C007J -W532/ C858J /CR/UTP/CL/RLP/CX	232 356 364	M5232 M5356 M5364	E6423R E6426R E6427R	D3219 D3222	H3265 H3268	P3813R-A P3816R-A P3817R-A	MH41	MT01	UYX128GAS #10
C007J -U532/ C858J /CR/UTQ/CL/RLP/CX	356 364	M5356 M5364	E6426R E6427R	D3222	H3268	P3816R-A P3817R-A	MH41	MT01	UYX128GAS #10
C007J -W922/ C858J CW	456 464	M5456 M5464	E1828P E1848P	D2107M	H4459M	P2428Q-A P2448Q-A	MH41	MT01B	SMX1014B#10 (M11014B#70,S17256)
C007J -W922/ C858J CW/UTP	456 464	M5456 M5464	E1828P E1848P	D2107M	H4459M	P2428Q-A P2448Q-A	MH41	MT01B	SMX1014B#10 (M11014B#70,S17256)
C007J -W922/ C858J CW/UTR	456 464	M5456 M5464	E1828P E1848P	D2107M	H4459M	P2428Q-A P2448Q-A	MH41	MT01B	SMX1014B#10 (M11014B#70,S17256)

筒車規格件表 / CONVERSION CHART

MODEL	SUB-CLASS	NEEDLE CLAMP	NEEDLE PLATE	MAIN FEED DOG	DIFF. FEED DOG	PRESSER FOOT	SPREADER	LOOPER	NEEDLE
機 型	規 格	針 座	針 板	主 送 具	差 送 具	押 具	上 叉	勾 針	針 號
C007J-W811 C858J /CRL/RL	248 356 364	M5248 M5356 M5364	E0215R E0216R E0217R	D2101Q	H2203R	P2765-A P2766-A P2767-A	MH41	MT01	TXX5 #14
C007J-W811A C858J /CRL/RL	248 356 364	M5248 M5356 M5364	E0215Q E0216Q E0217Q	D2101Q	H2203Q	P2765-A P2766-A P0967-A	—	MT01	TXX5 #14
C007J-W811 C858J CRL/UTP/RL	248 356 364	M5248 M5356 M5364	E0215R E0216R E0217R	D2101Q	H2203R	P2765-A P2766-A P2767-A	MH41	MT01	TXX5 #14
C007J-W811A C858J CRL/UTP/RL	248 356 364	M5248 M5356 M5364	E0215Q E0216Q E0217Q	D2101Q	H2203Q	P2765-A P2766-A P2767-A	MH41	MT01	TXX5 #14
C007J-U811 C858J CRL/UTQ/RL	248 356 364	M5248 M5356 M5364	E0215R E0216R E0217R	D2101Q	H2203R	P0965-A P0966-A P0967-A	—	MT01	TXX5 #14
C007J-U811A C858J CRL/UTQ/RL	248 356 364	M5248 M5356 M5364	E0215Q E0216Q E0217Q	D2101Q	H2203Q	P0965-A P0966-A P0967-A	—	MT01	TXX5 #14
C007J-W812 C858J /CRL/RL	248 356 364	M5248 M5356 M5364	E0223R E0225R E0226R	D2101Q	H2203R	P2763-A P2765-A P2766-A	MH41	MT01	UYX128GAS #10
C007J-W812A C858J /CRL/RL	248 356 364	M5248 M5356 M5364	E0225Q E0226Q E0227Q	D2101Q	H2203Q	P2765-A P2766-A P2767-A	MH41	MT01	UYX128GAS #10
C007J-U812 C858J /CRL/RL	248 356 364	M5248 M5356 M5364	E0225R E0226R E0227R	D2101Q	H2203R	P0965-A P0966-A P0967-A	—	MT01	UYX128GAS #10
C007J-U812A C858J /CRL/RL	248 356 364	M5248 M5356 M5364	E0225Q E0226Q E0227Q	D2101Q	H2203Q	P0965-A P0966-A P0967-A	—	MT01	UYX128GAS #10

註：C007J-W812A/W813A機型之針板與差送具為5排齒。

The needle plate and the differential feed dog of W812A/W813A model are five teeth.

C007J-W812/W813 機型之針板與差送具為4排齒。

The needle plate and the differential feed dog of W812/W813 model are four teeth.

筒車規格件表 / CONVERSION CHART

機型	規格	針座	針板	主送具	差送具	押具	上叉	勾針	針號
C007J-W812 C858J /CRL/UTP/RL	248 356 364	M5248 M5356 M5364	E0225R E0226R E0227R	D2101Q	H2203R	P2765-A P2766-A P2767-A	MH41	MT01	UYX128GAS #10
C007J-W812A C858J /CRL/UTP/RL	248 356 364	M5248 M5356 M5364	E0225Q E0226Q E0227Q	D2101Q	H2203Q	P2765-A P2766-A P2767-A	MH41	MT01	UYX128GAS #10
C007J-W812 C858J /CRL/UTQ/RL	248 356 364	M5248 M5356 M5364	E0225R E0226R E0227R	D2101Q	H2203R	P0965-A P0966-A P0967-A	—	MT01	UYX128GAS #10
C007J-W812A C858J /CRL/UTQ/RL	248 356 364	M5248 M5356 M5364	E0225Q E0226Q E0227Q	D2101Q	H2203Q	P0965-A P0966-A P0967-A	—	MT01	UYX128GAS #10
C007J-W812 C858J /CRL/UTR	248 356 364	M5248 M5356 M5364	E0225R E0226R E0227R	D2101Q	H2203R	P2765-A P2766-A P2767-A	MH41	MT01	UYX128GAS #10
C007J-W812A C858J /CRL/UTR	248 356 364	M5248 M5356 M5364	E0225Q E0226Q E0227Q	D2101Q	H2203Q	P2765-A P2766-A P2767-A	MH41	MT01	UYX128GAS #10
C007J-W812 C858J /CRL/UTS	248 356 364	M5248 M5356 M5364	E0225R E0226R E0227R	D2101Q	H2203R	P0965-A P0966-A P0967-A	MH41	MT01	UYX128GAS #10
C007J-W812A C858J /CRL/UTS	248 356 364	M5248 M5356 M5364	E0225Q E0226Q E0227Q	D2101Q	H2203Q	P0965-A P0966-A P0967-A	MH41	MT01	UYX128GAS #10
C007J-W813 C858J /CRL/RL	248 356 364	M5248 M5356 M5364	E0235R E0236R E0237R	D2101Q	H2203R	P2765-A P2766-A P2767-A	MH41	MT01	UYX128GAS #10
C007J-W813A C858J /CRL/RL	248 356 364	M5248 M5356 M5364	E0235Q E0236Q E0237Q	D2101Q	H2203Q	P2765-A P2766-A P2767-A	MH41	MT01	UYX128GAS #10
C007J-W813 C858J /CRL/RL	248 356 364	M5248 M5356 M5364	E0235R E0236R E0237R	D2101Q	H2203R	P0965-A P0966-A P0967-A	—	MT01	UYX128GAS #10
C007J-W813A C858J /CRL/RL	248 356 364	M5248 M5356 M5364	E0235Q E0236Q E0237Q	D2101Q	H2203Q	P0965-A P0966-A P0967-A	—	MT01	UYX128GAS #10









註：C007J-W812A/W813A機型之針板與差送具為5排齒。
C858J

The needle plate and the differential feed dog of W812A/W813A model are five teeth.

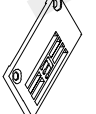
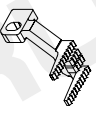
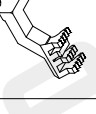
C007J-W812/W813 機型之針板與差送具為4排齒。

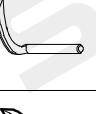
The needle plate and the differential feed dog of W812/W813 model are four teeth.

筒車規格件表 / CONVERSION CHART







機型	SUB-CLASS	規格	針座	針板	針板	主送具	差送具	押具	上叉	勾針	針號
											
MODEL	SUB-CLASS	規 格	NEEDLE CLAMP	NEEDLE PLATE	MAIN FEED DOG	DIFF. FEED DOG	PRESSER FOOT	SPREADER	LOOPER	NEEDLE	
機 型	規 格	針 座	針 板	針 板	主 送 具	差 送 具	押 具	上 叉	勾 針	針 號	
C007J-W813 C858J /CRL/UTR	248 356 364	M5248 M5356 M5364	E0235R E0236R E0237R	D2101Q	H2203R	P2765-A P2766-A P2767-A	MH41	MT01	TVX5 #14		
C007J-W813A C858J /CRL/UTR	248 356 364	M5248 M5356 M5364	E0235Q E0236Q E0237Q	D2101Q	H2203Q	P2765-A P2766-A P2767-A	MH41	MT01	TVX5 #14		
C007J-U813 C858J /CRL/UTS	248 356 364	M5248 M5356 M5364	E0235R E0236R E0237R	D2101Q	H2203R	P0965-A P0966-A P0967-A	MH41	MT01	TVX5 #14		
C007J-U813A C858J /CRL/UTS	248 356 364	M5248 M5356 M5364	E0235Q E0236Q E0237Q	D2101Q	H2203Q	P0965-A P0966-A P0967-A	MH41	MT01	TVX5 #14		
C007J-W822 C858J /CRL/CY/CL/RL	248 356 364	M5248 M5356 M5364	E0225R E0226R E0227R	D2101Q	H2203R	P2765-A P2766-A P2767-A	MH41	MT01	UYX128GAS #10		
C007J-W823 C858J /CRL/CY/CL/RL	248 356 364	M5248 M5356 M5364	E0235R E0236R E0237R	D2101Q	H2203R	P2765-A P2766-A P2767-A	MH41	MT01	TVX5 #14		
C007J-U822 C858J /CRL/CY/CL/RL	248 356 364	M5248 M5356 M5364	E0225R E0226R E0227R	D2101Q	H2203R	P0965-A P0966-A P0967-A	—	MT01	UYX128GAS #10		
C007J-U823 C858J /CRL/CY/CL/RL	248 356 364	M5248 M5356 M5364	E0235R E0236R E0237R	D2101Q	H2203R	P0965-A P0966-A P0967-A	—	MT01	TVX5 #14		
C007J-W822 C858J /CRL/CY/UTP/CL/RL	248 356 364	M5248 M5356 M5364	E0225R E0226R E0227R	D2101Q	H2203R	P2765-A P2766-A P2767-A	MH41	MT01	UYX128GAS #10		
C007J-W823 C858J /CRL/CY/UTP/CL/RL	248 356 364	M5248 M5356 M5364	E0235R E0236R E0237R	D2101Q	H2203R	P2765-A P2766-A P2767-A	MH41	MT01	TVX5 #14		

註：C007J-W812A/W813A機型之針板與差送具為5排齒。
C858J

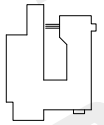
The needle plate and the differential feed dog of W812A/W813A model are five teeth.
C007J-W812/W813 機型之針板與差送具為4排齒。

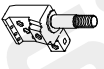
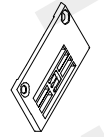
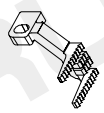
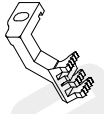
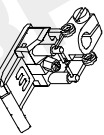
The needle plate and the differential feed dog of W812/W813 model are four teeth.

筒車規格件表 / CONVERSION CHART

機型	規格	針座	針板	主送具	差送具	押具	上叉	勾針	針號
 MODEL C007J_U822 C858J CRL/CY/UTQ/CL/RL	 SUB-CLASS 248 356 364	 NEEDLE CLAMP M5248 M5356 M5364	 NEEDLE PLATE E0225R E0226R E0227R	 MAIN FEED DOG D2101Q	 DIFF. FEED DOG H2203R	 PRESSER FOOT P0965-A P0966-A P0967-A	 SPREADER —	 LOOPER MT01	 NEEDLE UYX128GAS #10 TVX5 #4
C007J_U823 C858J CRL/CY/UTQ/CL/RL	248 356 364	M5248 M5356 M5364	E0235R E0236R E0237R	D2101Q	H2203R	P0965-A P0966-A P0967-A	—	MT01	TVX5 #4
C007J_U822 C858J CRL/CY/UTQ/CL/RL	248 356 364	M5248 M5356 M5364	E0225R E0226R E0227R	D2101Q	H2203R	P0965-A P0966-A P0967-A	—	MT01	UYX128GAS #10
C007J_U823 C858J CRL/CY/UTQ/CL/RL	248 356 364	M5248 M5356 M5364	E0235R E0236R E0237R	D2101Q	H2203R	P0965-A P0966-A P0967-A	—	MT01	TVX5 #4





筒車規格件表 / CONVERSION CHART

P11

機型 MODEL	規格 SUB-CLASS	針座 NEEDLE CLAMP	針板 NEEDLE PLATE	主送具 MAIN FEED DOG	差送具 DIFF. FEED DOG	押具 PRESSER FOOT	上叉 SPREADER	勾針 LOOPER	偏心凸輪 CAM	針號 NEEDLE
C007J-W522 C858J /FE(FFC)/CRA/CL	356 364	M5356 M5364	E 6426P E 6427P	D 3222	H 3268	P3116 P3117	MH41E	MT01	MF01-A	UYX128GAS #11
C007J-U522 C858J /FE(FFC)/CRB/CL	356 364	M5356 M5364	E 6426P E 6427P	D 3222	H 3268	P3116 P3117	MH41E	MT01	MF01-A	UYX128GAS #11
C007J-U532/ C858J GRA/UTQ/CL/RLP/CX-A	356 364	M5356 M5364	E 6426P E 6427P	D 3222	H 3268	P3816Q P3817Q	—	MT01	MF01-A	UYX128GAS #11
C007J-U532/ C858J GRA/UTP/CL/RLP/CX-B	356 364	M5356 M5364	E 6426P E 6427P	D 3222	H 3268	P3816Q P3817Q	MH41E	MT01	MF01-A	UYX128GAS #11
C007J-U532/ C858J GRA/UTQ/CL/RLP/CX-B	356 364	M5356 M5364	E 6426P E 6427P	D 3222	H 3268	P3816Q P3817Q	MH41E	MT01	MF01-A	UYX128GAS #11

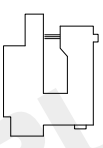
簡單直驅伺服馬達規格件表 / CONVERSION CHART

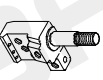
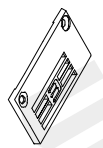
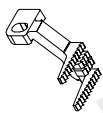
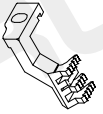
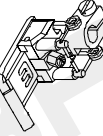
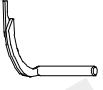
P1

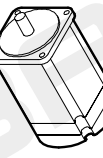
MODEL	SUB-CLASS	NEEDLE CLAMP	NEEDLE PLATE	MAIN FEED DOG	DIFF. FEED DOG	PRESSER FOOT	SPREADER	LOOPER	NEEDLE	馬達 Motor
										
機 型	規 格	針 座	針 板	主送具	差送具	押 具	上 叉	勾 針	針 號	馬 達
C007JD-W121 C858JD /CH	356 364	M5356 M5364	E3816P E3817P	D4206 D4207	H4458 H4459	P2446-A P2447-A	MH41	MT01	YXX128GAS #10	T501HE
C007JD-U121 C858JD /CH	356 364	M5356 M5364	E3816P E3817P	D4206 D4207	H4458 H4459	P2446-A P2447-A	—	MT01	YXX128GAS #10	
C007JD-U121 C858JD /CH	356 364	M5356 M5364	E3816P E3817P	D4206 D4207	H4458 H4459	P2446-A P2447-A	—	MT01	YXX128GAS #10	
C007JD-U121 C858JD /CH	356 364	M5356 M5364	E3816P E3817P	D4206 D4207	H4458 H4459	P2446-A P2447-A	—	MT01	YXX128GAS #10	
C007JD-U121 C858JD /CH	356 364	M5356 M5364	E3816P E3817P	D4206 D4207	H4458 H4459	P2446-A P2447-A	—	MT01	YXX128GAS #10	
C007JD-U121 C858JD /CH	356 364	M5356 M5364	E3816P E3817P	D4206 D4207	H4458 H4459	P2446-A P2447-A	—	MT01	YXX128GAS #10	
C007JD-U121 C858JD /CH	356 364	M5356 M5364	E3816P E3817P	D4206 D4207	H4458 H4459	P2446-A P2447-A	—	MT01	YXX128GAS #10	
C007JD-U121 C858JD /CH	356 364	M5356 M5364	E3816P E3817P	D4206 D4207	H4458 H4459	P2446-A P2447-A	—	MT01	YXX128GAS #10	
C007JD-U121 C858JD /CH	356 364	M5356 M5364	E3816P E3817P	D4206 D4207	H4458 H4459	P2446-A P2447-A	—	MT01	YXX128GAS #10	
C007JD-U121 C858JD /CH	356 364	M5356 M5364	E3816P E3817P	D4206 D4207	H4458 H4459	P2446-A P2447-A	—	MT01	YXX128GAS #10	
C007JD-U121 C858JD /CH	356 364	M5356 M5364	E3816P E3817P	D4206 D4207	H4458 H4459	P2446-A P2447-A	—	MT01	YXX128GAS #10	
C007JD-U121 C858JD /CH	356 364	M5356 M5364	E3816P E3817P	D4206 D4207	H4458 H4459	P2446-A P2447-A	—	MT01	YXX128GAS #10	

註：P2544-A/P2545-A為固定式押具舌，亦可使用活動式押具舌 P2565-A代替P2544-A/P2545-A

P2544-A/P2545-A is the fixed presser foot tongue. It can be replaced by the removable presser foot tongue P2565-A.







P2446-A/P2447-A為固定式押具舌，亦可使用活動式押具舌 P2466-A代替P2446-A/P2447-A

P2446-A/P2447-A is the fixed presser tongue. It can be replaced by the removable presser foot tongue P2466-A.

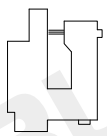
09/12/11

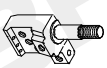
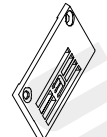
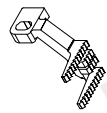
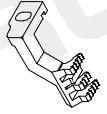
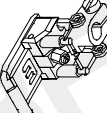
筒車直軀伺服馬達規格件表 / CONVERSION CHART

P2

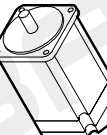
機型	SUB-CLASS	針座	針板	主送具	差送具	押具	上叉	勾針	針號	馬達
										
C007JD-U122 C858JD CH/UTQ(UTS)	240 248 256 356 364	M5240 M5248 M5356 M5356 M5364	E3524P E3525P E3826S E3826P E3827P	D4206 D4206 D4206 D4206 D4207	H4458 H4458 H4458 H4458 H4459	P2544-A P2545-A P2446-A P2446-A P2447-A	—	MT01	UYX128GAS #10	馬達
C007JD-W122 C858JD /CHA	356	M5356	E3826Q	D4206	H4458	P0216-A	—	MT01	UYX128GAS #10	
C007JD-U122 C858JD /CHA	356	M5356	E3826Q	D4206	H4458	P0416-A	—	MT01	UYX128GAS #10	
C007JD-U123 C858JD /CH	240 248 356 364	M5240 M5248 M5356 M5364	E3534P E3535P E3836P E3837P	D4206 D4206 D4206 D4207	H4458 H4458 H4458 H4459	P2544-A P2545-A P2446-A P2447-A	MH41	MT01	UYX128GAS #10	
C007JD-U123 C858JD /CHE	240 248 356 364	M5240 M5248 M5356 M5364	E2324P E2325P E2326P E2327P	D2109 D2109 D2110 D2110	H2219 H2219 H2220 H2220	P2904-A P2905-A P2906-A P2907-A	MH41	MT01	UYX128GAS #10	
C007JD-W132 C858JD /CHE/UTP(UTR)	356 364	M5356 M5364	E2326P E2327P	D2110	H2220	P2906-A P2907-A	MH41	MT01	UYX128GAS #10	

☐ T501HE







註：P2544-A/P2545-A為固定式押具舌，亦可使用活動式押具舌 P2565-A代替 P2544-A/P2545-A

P2544-A/P2545-A is the fixed presser foot tongue. It can be replaced by the removable presser foot tongue P2565-A.

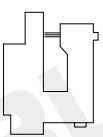
P2446-A/P2447-A為固定式押具舌，亦可使用活動式押具舌 P2466-A代替 P2446-A/P2447-A

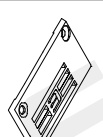
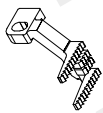
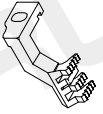
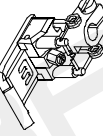
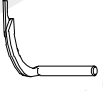
P2446-A/P2447-A is the fixed presser tongue. It can be replaced by the removable presser foot tongue P2466-A.

筒車直驅伺服馬達規格件表 / CONVERSION CHART

MODEL	SUB-CLASS	NEEDLE CLAMP	NEEDLE PLATE	MAIN FEED DOG	DIFF. FEED DOG	PRESSER FOOT	SPREADER	LOOPER	NEEDLE	馬達
										
機型	規格	針座	針板	主送具	差送具	押具	上叉	勾針	針號	
C007JD-W152 C858JD /CZP/RLQ	356 364	M5356 M5364	E4326 E4327	D3216 D3217	H3262 H3263	P2416-A P2417-A	MH41	MT01	UYX128GAS #10	T501HE
C007JD-U152 C858JD /CZP/RLQ	356 364	M5356 M5364	E4326 E4327	D3216 D3217	H3262 H3263	P2416-A P2417-A	—	MT01	UYX128GAS #10	
C007JD-W152 C858JD CZP/CLA/RLQ	356 364	M5356 M5364	E4326 E4327	D3216 D3217	H3262 H3263	P2416-A P2417-A	MH41	MT01	UYX128GAS #10	
C007JD-U152 C858JD CZP/CLA/RLQ	356 364	M5356 M5364	E4326 E4327	D3216 D3217	H3262 H3263	P2416-A P2417-A	—	MT01	UYX128GAS #10	
C007JD-W162 C858JD	240 248 356 364	M5240 M5248 M5356 M5356	E3544 E3545 E3846 E3847	D4206 D4206 D4206 D4207	H4458 H4458 H4458 H4459	P2544-A P2545-A P2446-A P2447-A	—	MT01A	TVX5 #14~16	
C007JD-U162 C858JD	240 248 356 364	M5240 M5248 M5356 M5364	E3544 E3545 E3846 E3847	D4206 D4206 D4206 D4207	H4458 H4458 H4458 H4459	P2544-A P2545-A P2446-A P2447-A	MH41	MT01A	TVX5 #14~16	
C007JD-W162 C858JD /UTP (UTR)	240 248 356 364	M5240 M5248 M5356 M5364	E3544 E3545 E3846 E3847	D4206 D4206 D4206 D4207	H4458 H4458 H4458 H4459	P2544-A P2545-A P2446-A P2447-A	—	MT01A	TVX5 #14~16	
C007JD-U162 C858JD /UTQ (UTS)	240 248 356 364	M5240 M5248 M5356 M5356	E3544 E3545 E3846 E3847	D4206 D4206 D4206 D4207	H4458 H4458 H4458 H4459	P2544-A P2545-A P2446-A P2447-A	—	MT01A	TVX5 #14~16	

註：P2544-A/P2545-A為固定式押具舌，亦可使用活動式押具舌 P2565-A代替P2544-A/P2545-A



P2544-A/P2545-A is the fixed presser foot tongue. It can be replaced by the removable presser foot tongue P2565-A.

P2446-A/P2447-A為固定式押具舌，亦可使用活動式押具舌 P2466-A代替P2446-A/P2447-A

P2446-A/P2447-A is the fixed presser tongue. It can be replaced by the removable presser foot tongue P2466-A.

筒車直驅伺服馬達規格件表 / CONVERSION CHART

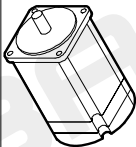
P4

MODEL	SUB-CLASS	NEEDLE CLAMP	NEEDLE PLATE	MAIN FEED DOG	DIFF. FEED DOG	PRESSER FOOT	SPREADER	LOOPER	NEEDLE	馬達	
C007JD-W222 C858JD /CC	240	M5240	E4124P	D3216	H3362	P1814-A	MH41	MT01	YXX128GAS #10	 Motor 馬達	
	248	M5248	E4125P	D3216	H3362	P1815-A	—				
C007JD-U222 C858JD /CQ	356	M5356	E4426P	D3216	H3362	P2116-A	—	MT01	YXX128GAS #10		
	364	M5364	E4427P	D3217	H3363	P2117-A	—				
C007JD-C858JD /COA/CLA	256	M5356	E2326Q	D2110	H2220Q	P2906Q-A	MH41	MT01A	TVX5 #14		
C007JD-W322 C858JD /CC	356	M5356	E2826P	D2107L	H3259M	P2456-A	MH41	MT01	YXX128GAS #10		 T501HE
	364	M5364	E2827P	D2107L	H3259M	P2457-A	—				
C007JD-U322 C858JD /CC	356	M5356	E2826P	D2107L	H3259M	P2456-A	—	MT01	YXX128GAS #10		
	364	M5364	E2827P	D2107L	H3259M	P2457-A	MH41	MT01	YXX128GAS #10		
C007JD-W322 C858JD /CC/UTP(UTR)	356	M5356	E2826P	D2107L	H3259M	P2456-A	—	MT01	YXX128GAS #10		
	364	M5364	E2827P	D2107L	H3259M	P2457-A	MH41	MT01	YXX128GAS #10		
C007JD-U322 C858JD /CC/UTQ(UTS)	356	M5356	E2826P	D2107L	H3259M	P2456-A	—	MT01	YXX128GAS #10		
	364	M5364	E2827P	D2107L	H3259M	P2457-A	—	MT01	YXX128GAS #10		

註(1) : P2544-A/P2545-A為固定式押具舌,亦可使用活動式押具舌 P2565-A代替 P2544-A/P2545-A
 P2544-A/P2545-A is the fixed presser foot tongue. It can be replaced by the removable presser foot tongue P2565-A.
 P2446-A/P2447-A為固定式押具舌,亦可使用活動式押具舌 P2466-A代替 P2446-A/P2447-A
 P2446-A/P2447-A is the fixed presser tongue. It can be replaced by the removable presser foot tongue P2466-A.











09/12/11

註(2) : C007JD-W/U322A-356 /CC 時, 該針板與送具改用 C007JD-W/U122-356 之針板與送具, 加附CHJ-A
 C858JD

When W/U322A-356 /CC, The needle plate and the feed dog have to be replaced by C007JD-W/U122-356 needle plate and the feed dog, with CHJ-A attached.

筒車直驅伺服馬達規格件表 / CONVERSION CHART

P5

MODEL	SUB-CLASS	NEEDLE CLAMP	NEEDLE PLATE	MAIN FEED DOG	DIFF. FEED DOG	PRESSER FOOT	SPREADER	LOOPER	NEEDLE	馬達 Motor
										
C007JD-W322 C858JD /CE	356 364	M5356 M5364	E2626P E2627P	D2107	H3159	P2456-A P2457-A	MH41	MT01	UYX128GAS #10	T501HE
C007JD-U322 C858JD /CE	356 364	M5356 M5364	E2626P E2627P	D2107	H3159	P2456-A P2457-A	—	MT01	UYX128GAS #10	
C007JD-W322 C858JD /CE/UTP(UTR)	356 364	M5356 M5364	E2626P E2627P	D2107	H3159	P2456-A P2457-A	MH41	MT01	UYX128GAS #10	
C007JD-U322 C858JD /CE/UTQ(UTS)	356 364	M5356 M5364	E2626P E2627P	D2107	H3159	P2456-A P2457-A	—	MT01	UYX128GAS #10	





註：P2544-A/P2545-A為固定式押具舌，亦可使用活動式押具舌 P2565-A代替P2544-A/P2545-A

P2544-A/P2545-A is the fixed presser foot tongue. It can be replaced by the removable presser foot tongue P2565-A.

P2446-A/P2447-A為固定式押具舌，亦可使用活動式押具舌 P2466-A代替P2446-A/P2447-A

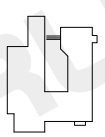
P2446-A/P2447-A is the fixed presser tongue. It can be replaced by the removable presser foot tongue P2466-A.

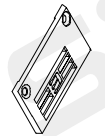
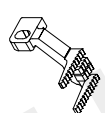
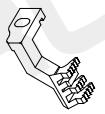
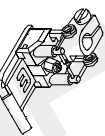
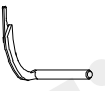
筒車直驅何服馬達規格件表 / CONVERSION CHART

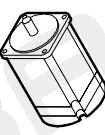
機型	SUB-CLASS	針座	針板	主送具	差送具	押具	上叉	勾針	針號	馬達
										
C007JD-W512 C858JD /FE	240 356 364	M5240 M5356 M5364	E3524R E3826R E3827R	D4206 D4206 D4207	H4458 H4458 H4459	P2914-A P3216-A P3217-A	MH41	MT01	YYX128GAS #10	馬達 T501HE
C007JD-U512 C858JD /FE	240 356 364	M5240 M5356 M5364	E3524R E3826R E3827R	D4206 D4206 D4207	H4458 H4458 H4459	P3414-A P3716-A P3717-A	—	MT01	YYX128GAS #10	
C007JD-W522 C858JD /FE/CR/CL	356 364	M5356 M5364	E6426R E6427R	D3222	H3268	P3816R-A P3817R-A	MH41	MT01	YYX128GAS #10	
C007JD-U522 C858JD /FE/CR/CL	356 364	M5356 M5364	E6426R E6427R	D3222	H3268	P3816R-A P3817R-A	—	MT01	YYX128GAS #10	
C007JD-W532/ C858JD CR/UTP/CL/RLP/CX	356 364	M5356 M5364	E6426R E6427R	D3222	H3268	P3816R-A P3817R-A	MH41	MT01	YYX128GAS #10	
C007JD-U532/ C858JD CR/UTP/CL/RLP/CX	356 364	M5356 M5364	E6426R E6427R	D3222	H3268	P3816R-A P3817R-A	MH41	MT01	YYX128GAS #10	
C007JD-W922/ C858JD CW	456 464	M5456 M5464	E1828P E1848P	D2107M	H4459M	P2428Q-A P2448Q-A	MH41	MT01B	SNX1014B#10 (MY1014B#70,S,Y7256)	
C007JD-W922/ C858JD CW/UTP	456 464	M5456 M5464	E1828P E1848P	D2107M	H4459M	P2428Q-A P2448Q-A	MH41	MT01B	SNX1014B#10 (MY1014B#70,S,Y7256)	
C007JD-W922/ C858JD CW/UTR	456 464	M5456 M5464	E1828P E1848P	D2107M	H4459M	P2428Q-A P2448Q-A	MH41	MT01B	SNX1014B#10 (MY1014B#70,S,Y7256)	

註： C007JD/C858JD不可加裝FFC

FFC can not be attached to C007JD/C858JD.

筒車直驅伺服馬達規格件表 / CONVERSION CHART

P7

機型	SUB-CLASS	針座	針板	主送具	差送具	押具	上叉	勾針	針號	馬達
C007JD -W811 C858JD /CRL/RL	248	M5248	E0215R	D2101Q	H2203R	P2765-A	MH41	MT01	TXV5 #14	Motor
	356	M5356	E0216R	D2101Q	H2203R	P2766-A	MH41	MT01	TXV5 #14	
	364	M5364	E0217R	D2101Q	H2203Q	P2767-A	MH41	MT01	TXV5 #14	
	248	M5248	E0215Q	D2101Q	H2203Q	P2765-A	—	MT01	TXV5 #14	
C007JD -W811A C858JD /CRL/RL	248	M5248	E0215Q	D2101Q	H2203Q	P2765-A	—	MT01	TXV5 #14	Motor
	356	M5356	E0216Q	D2101Q	H2203Q	P2766-A	—	MT01	TXV5 #14	
	364	M5364	E0217Q	D2101Q	H2203R	P2767-A	—	MT01	TXV5 #14	
	248	M5248	E0215Q	D2101Q	H2203Q	P2765-A	—	MT01	TXV5 #14	
C007JD -W811A C858JD /CRL/RL	248	M5248	E0215Q	D2101Q	H2203Q	P2765-A	—	MT01	TXV5 #14	Motor
	356	M5356	E0216Q	D2101Q	H2203Q	P2766-A	—	MT01	TXV5 #14	
	364	M5364	E0217Q	D2101Q	H2203R	P2767-A	—	MT01	TXV5 #14	
	248	M5248	E0215Q	D2101Q	H2203Q	P2765-A	—	MT01	TXV5 #14	
C007JD -W812 C858JD /CRL/RL	248	M5248	E0225R	D2101Q	H2203R	P2765-A	MH41	MT01	UYX128GAS #10	Motor
	356	M5356	E0226R	D2101Q	H2203R	P2766-A	MH41	MT01	UYX128GAS #10	
	364	M5364	E0227R	D2101Q	H2203Q	P2767-A	MH41	MT01	UYX128GAS #10	
	248	M5248	E0225R	D2101Q	H2203R	P2765-A	—	MT01	UYX128GAS #10	
C007JD -U812 C858JD /CRL/RL	248	M5248	E0225R	D2101Q	H2203R	P2765-A	—	MT01	UYX128GAS #10	Motor
	356	M5356	E0226R	D2101Q	H2203R	P2766-A	—	MT01	UYX128GAS #10	
	364	M5364	E0227R	D2101Q	H2203Q	P2767-A	—	MT01	UYX128GAS #10	
	248	M5248	E0225R	D2101Q	H2203R	P2765-A	—	MT01	UYX128GAS #10	
C007JD -U812A C858JD /CRL/RL	248	M5248	E0225Q	D2101Q	H2203Q	P2765-A	—	MT01	UYX128GAS #10	Motor
	356	M5356	E0226Q	D2101Q	H2203Q	P2766-A	—	MT01	UYX128GAS #10	
	364	M5364	E0227Q	D2101Q	H2203R	P2767-A	—	MT01	UYX128GAS #10	
	248	M5248	E0225Q	D2101Q	H2203Q	P2765-A	—	MT01	UYX128GAS #10	

□ T501HE







註：C007JD -W812A/W813A機型之針板與差送具為5排齒。

The needle plate and the differential feed dog of W812A/W813A model are five teeth.

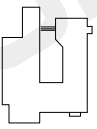
C007JD -W812/W813 機型之針板與差送具為4排齒。

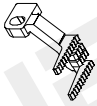
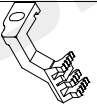
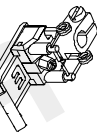
The needle plate and the differential feed dog of W812/W813 model are four teeth.

筒車直驅伺服馬達規格件表 / CONVERSION CHART

MODEL	SUB-CLASS	NEEDLE CLAMP	NEEDLE PLATE	MAIN FEED DOG	DIFF. FEED DOG	PRESSER FOOT	SPREADER	LOOPER	NEEDLE	馬達 Motor
										
機型	規格	針座	針板	主送具	差送具	押具	上叉	勾針	針號	馬達
C007JD-W812 C858JD CRL/UTP/RL	248 356 364	M5248 M5356 M5364	E0225R E0226R E0227R	D2101Q	H2203R	P2765-A P2766-A P2767-A	MH41	MT01	YXX128GAS #10	
C007JD-W812A C858JD CRL/UTP/RL	248 356 364	M5248 M5356 M5364	E0225Q E0226Q E0227Q	D2101Q	H2203Q	P0965-A P0966-A P0967-A	—	MT01	YXX128GAS #10	
C007JD-W812 C858JD /CRL/UTR	248 356 364	M5248 M5356 M5364	E0225R E0226R E0227R	D2101Q	H2203R	P2765-A P2766-A P2767-A	MH41	MT01	YXX128GAS #10	
C007JD-W812A C858JD /CRL/UTR	248 356 364	M5248 M5356 M5364	E0225Q E0226Q E0227Q	D2101Q	H2203Q	P0965-A P0966-A P0967-A	MH41	MT01	YXX128GAS #10	
C007JD-W812 C858JD /CRL/UTS	248 356 364	M5248 M5356 M5364	E0225R E0226R E0227R	D2101Q	H2203R	P0965-A P0966-A P0967-A	MH41	MT01	YXX128GAS #10	
C007JD-W812A C858JD /CRL/UTS	248 356 364	M5248 M5356 M5364	E0225Q E0226Q E0227Q	D2101Q	H2203Q	P0965-A P0966-A P0967-A	MH41	MT01	YXX128GAS #10	
C007JD-W813 C858JD /CRL/RL	248 356 364	M5248 M5356 M5364	E0235R E0236R E0237R	D2101Q	H2203R	P2765-A P2766-A P2767-A	MH41	MT01	YXX128GAS #10	
C007JD-W813A C858JD /CRL/RL	248 356 364	M5248 M5356 M5364	E0235Q E0236Q E0237Q	D2101Q	H2203Q	P2765-A P2766-A P2767-A	MH41	MT01	YXX128GAS #10	
C007JD-W813 C858JD /CRL/RL	248 356 364	M5248 M5356 M5364	E0235R E0236R E0237R	D2101Q	H2203R	P0965-A P0966-A P0967-A	—	MT01	YXX128GAS #10	
C007JD-W813A C858JD /CRL/RL	248 356 364	M5248 M5356 M5364	E0235Q E0236Q E0237Q	D2101Q	H2203Q	P0965-A P0966-A P0967-A	—	MT01	YXX128GAS #10	

☐ T501HE

註：C007JD-W812A/W813A機型之針板與差送具為5排齒。

The needle plate and the differential feed dog of W812A/W813A model are five teeth.

C007JD-W812/W813機型之針板與差送具為4排齒。

The needle plate and the differential feed dog of W812/W813 model are four teeth.

筒車直驅伺服馬達規格件表 / CONVERSION CHART

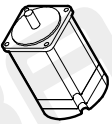
機型	規格	針座	針板	主送具	差送具	押具	上叉	勾針	針號	馬達
C007JD-W813 C858JD /CRL/UTR	248 356 364	M5248 M5356 M5364	E0235R E0236R E0237R	D2101Q	H2203R	P2765-A P2766-A P2767-A	MH41	MT01	TVX5 #14	
C007JD-W813A C858JD /CRL/UTR	248 356 364	M5248 M5356 M5364	E0235Q E0236Q E0237Q	D2101Q	H2203Q	P2765-A P2766-A P2767-A	MH41	MT01	TVX5 #14	
C007JD-W813 C858JD /CRL/UTS	248 356 364	M5248 M5356 M5364	E0235R E0236R E0237R	D2101Q	H2203R	P0965-A P0966-A P0967-A	MH41	MT01	TVX5 #14	
C007JD-W813A C858JD /CRL/UTS	248 356 364	M5248 M5356 M5364	E0235Q E0236Q E0237Q	D2101Q	H2203Q	P0965-A P0966-A P0967-A	MH41	MT01	TVX5 #14	
C007JD-W822 C858JD /CRL/CY/CL/RL	248 356 364	M5248 M5356 M5364	E0225R E0226R E0227R	D2101Q	H2203R	P2765-A P2766-A P2767-A	MH41	MT01	UYXX128GAS #10	
C007JD-W822 C858JD /CRL/CY/CL/RL	248 356 364	M5248 M5356 M5364	E0225R E0226R E0227R	D2101Q	H2203R	P2765-A P2766-A P2767-A	MH41	MT01	TVX5 #14	
C007JD-W823 C858JD /CRL/CY/CL/RL	248 356 364	M5248 M5356 M5364	E0235R E0236R E0237R	D2101Q	H2203R	P0965-A P0966-A P0967-A	—	MT01	TVX5 #14	
C007JD-W823 C858JD /CRL/CY/CL/RL	248 356 364	M5248 M5356 M5364	E0235R E0236R E0237R	D2101Q	H2203R	P0965-A P0966-A P0967-A	—	MT01	UYXX128GAS #10	
C007JD-W823 C858JD /CRL/CY/CL/RL	248 356 364	M5248 M5356 M5364	E0225R E0226R E0227R	D2101Q	H2203R	P2765-A P2766-A P2767-A	MH41	MT01	TVX5 #14	
C007JD-W823 C858JD /CRL/CY/CL/RL	248 356 364	M5248 M5356 M5364	E0235R E0236R E0237R	D2101Q	H2203R	P2765-A P2766-A P2767-A	MH41	MT01	UYXX128GAS #10	
C007JD-W823 C858JD /CRL/CY/CL/RL	248 356 364	M5248 M5356 M5364	E0235R E0236R E0237R	D2101Q	H2203R	P2765-A P2766-A P2767-A	MH41	MT01	TVX5 #14	
C007JD-W823 C858JD /CRL/CY/CL/RL	248 356 364	M5248 M5356 M5364	E0235R E0236R E0237R	D2101Q	H2203R	P2765-A P2766-A P2767-A	MH41	MT01	UYXX128GAS #10	

 T501HE









註：C007JD-W812A/W813A 機型之針板與差送具為 5 排齒。
C858JD

The needle plate and the differential feed dog of W812A/W813A model are five teeth.

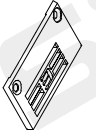
C007JD-W812/W813 機型之針板與差送具為 4 排齒。
C858JD

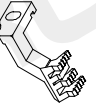
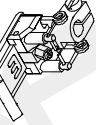
The needle plate and the differential feed dog of W812/W813 model are four teeth.

筒車直驅伺服馬達規格件表 / CONVERSION CHART

MODEL	SUB-CLASS	NEEDLE CLAMP	NEEDLE PLATE	MAIN FEED DOG	DIFF. FEED DOG	PRESSER FOOT	SPREADER	LOOPER	NEEDLE 針號	Motor
										
機 型	規 格	針 座	針 板	主 送 具	差 送 具	押 具	上 叉	勾 針	針 號	馬 達
C007JD-U822 C858JD CRL/CY/UTQ/CL/RL	248 356 364	M5248 M5356 M5364	E0225R E0226R E0227R	D2101Q	H2203R	P0965-A P0966-A P0967-A	—	MT01	UYX128GAS #10	T501HE
C007JD-U823 C858JD CRL/CY/UTQ/CL/RL	248 356 364	M5248 M5356 M5364	E0235R E0236R E0237R	D2101Q	H2203R	P0965-A P0966-A P0967-A	—	MT01	TVX5 #14	
C007JD-U822 C858JD CRL/CY/UTQ/CL/RL	248 356 364	M5248 M5356 M5364	E0225R E0226R E0227R	D2101Q	H2203R	P0965-A P0966-A P0967-A	—	MT01	UYX128GAS #10	
C007JD-U823 C858JD CRL/CY/UTQ/CL/RL	248 356 364	M5248 M5356 M5364	E0235R E0236R E0237R	D2101Q	H2203R	P0965-A P0966-A P0967-A	—	MT01	TVX5 #14	

筒車直驅伺服馬達規格件表 / CONVERSION CHART

P11

機型	SUB-CLASS	規格	針座	針板	主送具	差送具	押具	上叉	勾針	偏心凸輪	針號
C007JD -W522 C858JD /FE(FEC)/CRB/CL	356 364	M5356 M5364	E 6426P E 6427P	D 3222	H 3268	P3116 P3117	MH41E	MT01	MF01 -A	UYX128GAS #11	
C007JD -U522 C858JD /FE(FEC)/CRB/CL	356 364	M5356 M5364	E 6426P E 6427P	D 3222	H 3268	P3116 P3117	—	MT01	MF01 -A	UYX128GAS #11	
C007JD -W812 C858JD /CRL/RL	248 356 364	M5248 M5356 M5364	E 0225R E 0226R E 0227R	D2101Q	H2203R	P2765 P2766 P2767	MH41E	MT01	MF91 -A	UYX128GAS #11	
C007JD -U812 C858JD /CRL/RL	248 356 364	M5248 M5356 M5364	E 0225R E 0226R E 0227R	D2101Q	H2203R	P0965 P0966 P0967	—	MT01	MF91 -A	UYX128GAS #11	
C007JD -W813 C858JD /CRL/RL	248 356 364	M5248 M5356 M5364	E 0235R E 0236R E 0237R	D2101Q	H2203R	P2765 P2766 P2767	MH41E	MT01	MF91 -A	UYX128GAS #11	
C007JD -U813 C858JD /CRL/RL	248 356 364	M5248 M5356 M5364	E 0235R E 0236R E 0237R	D2101Q	H2203R	P0965 P0966 P0967	—	MT01	MF91 -A	UYX128GAS #11	

C007JD PARTS LIST FOR MF GROUP P.1/1

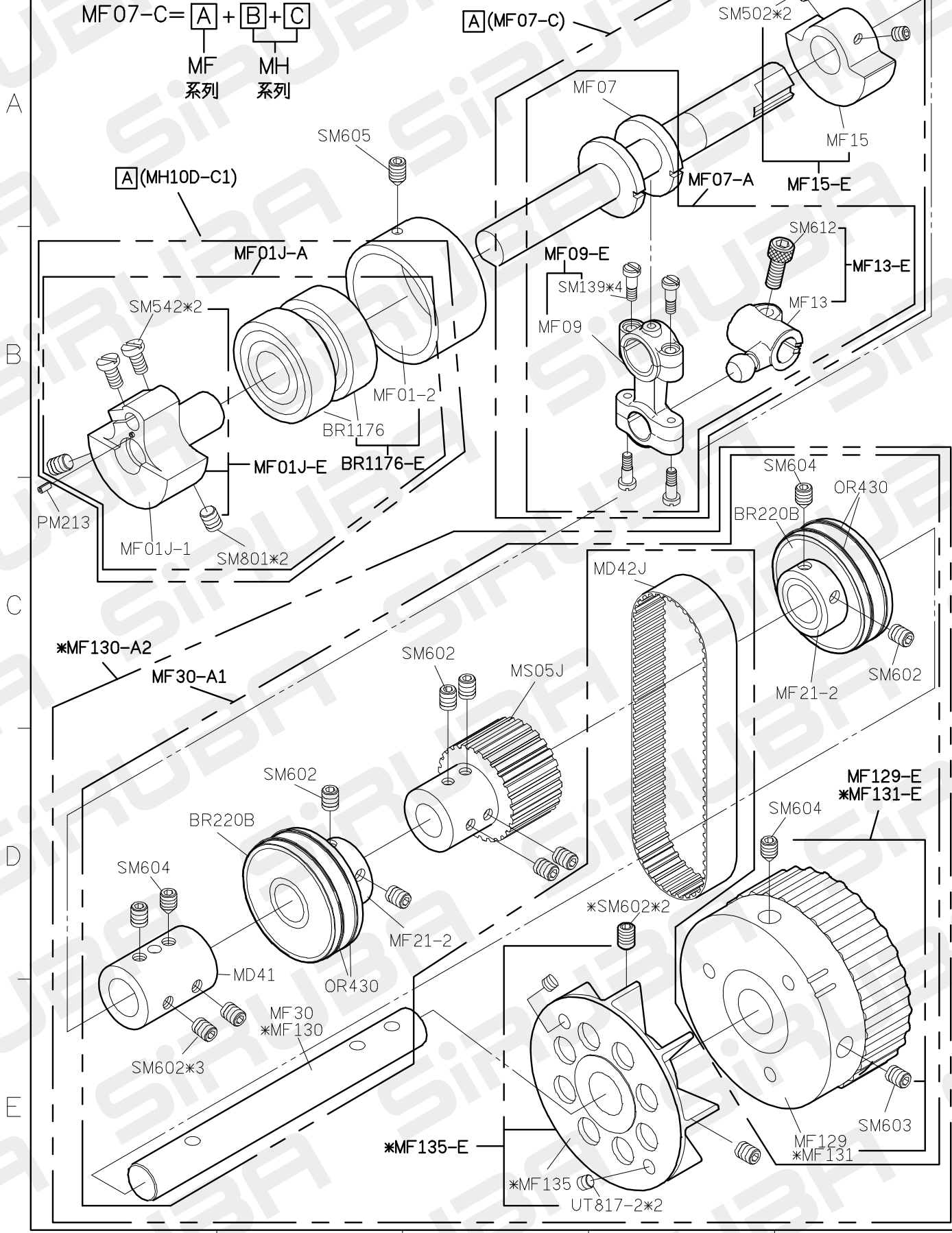

C007JD PARTS LIST FOR MG GROUP P.1/1

A

B

C

D

E

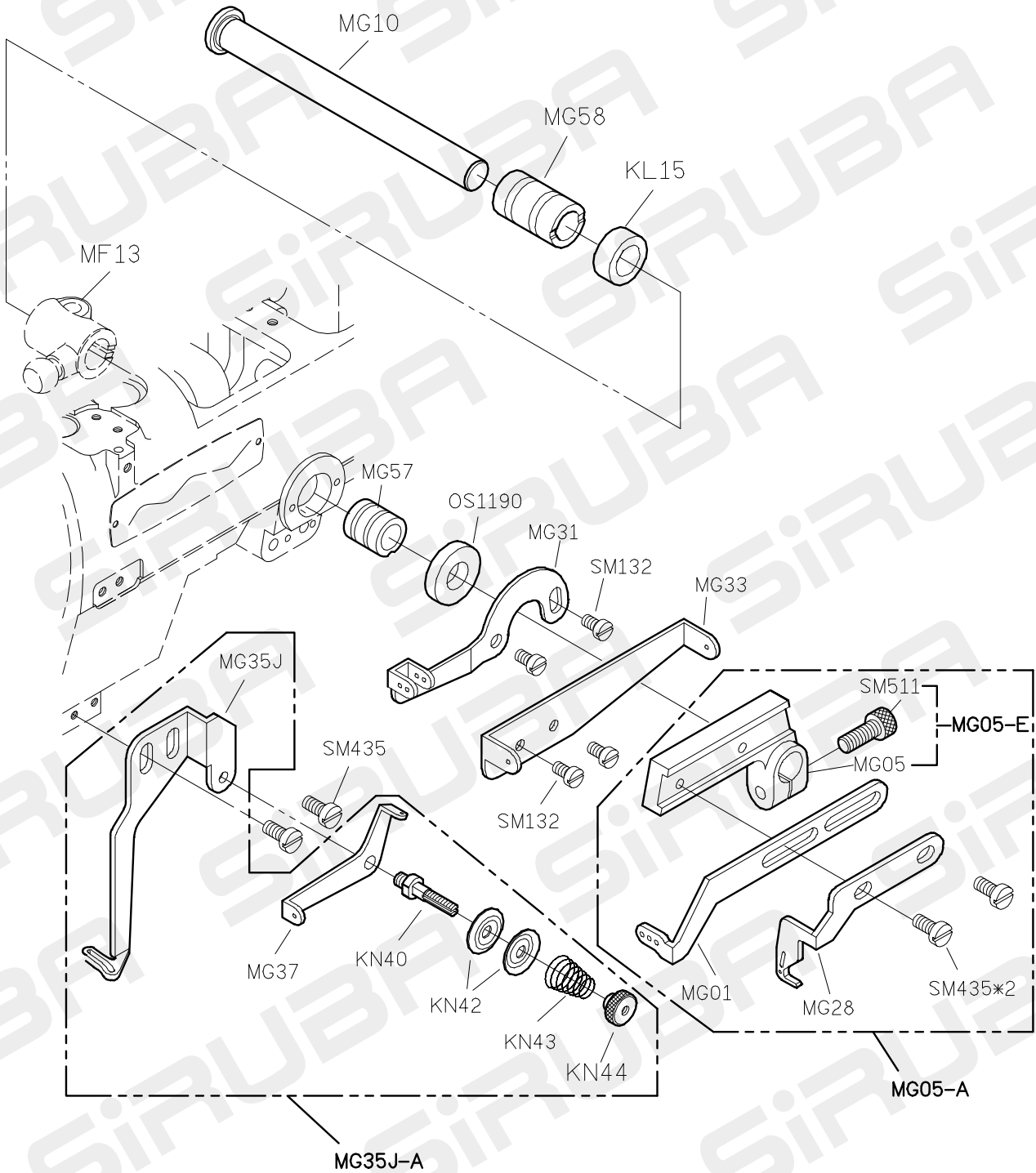

C007JD PARTS LIST FOR MH GROUP P.1/1

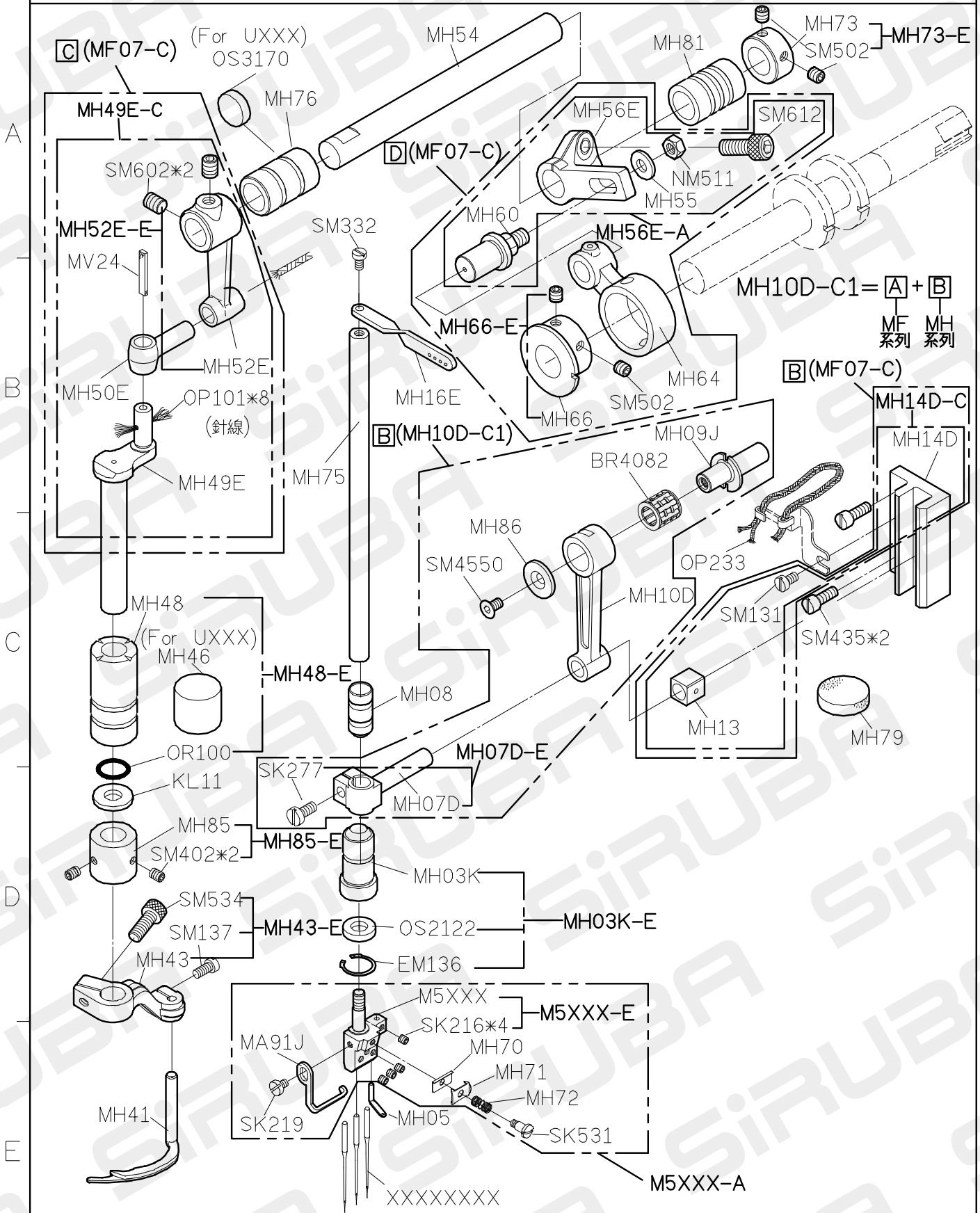

C007JD PARTS LIST FOR MJ GROUP P.1/1

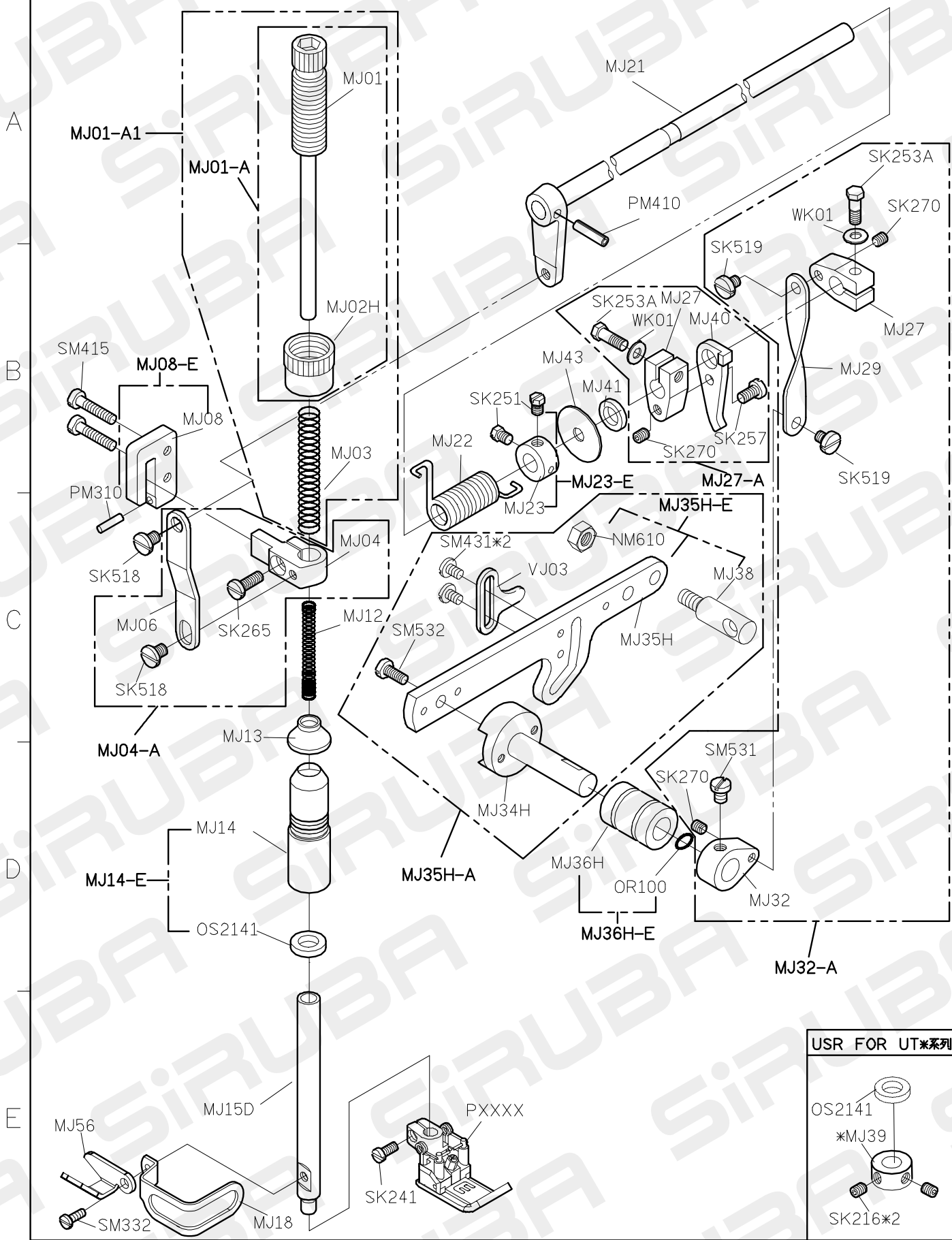

C007JD PARTS LIST FOR MK GROUP P.1/1

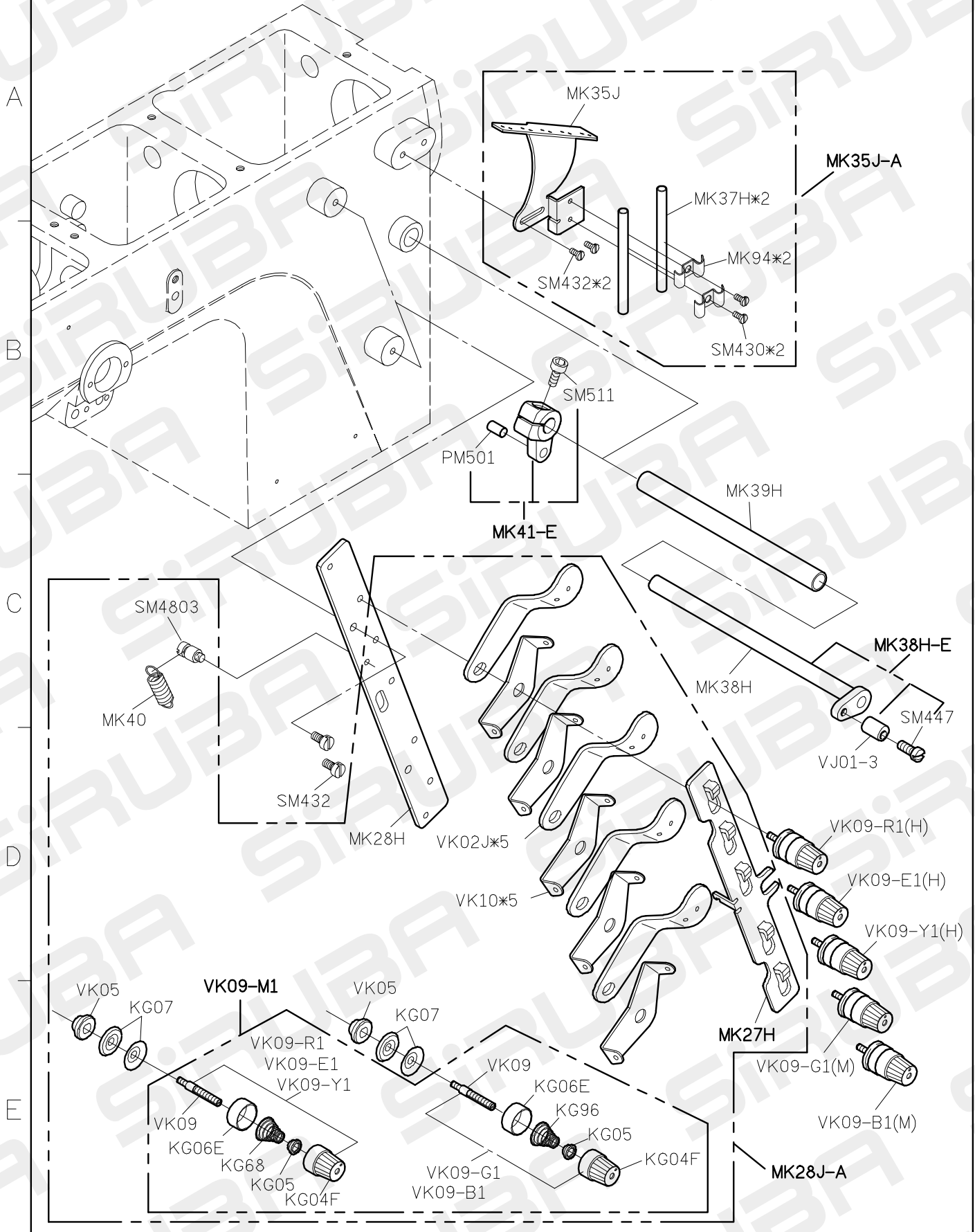

C007JD PARTS LIST FOR MN GROUP P.1/2

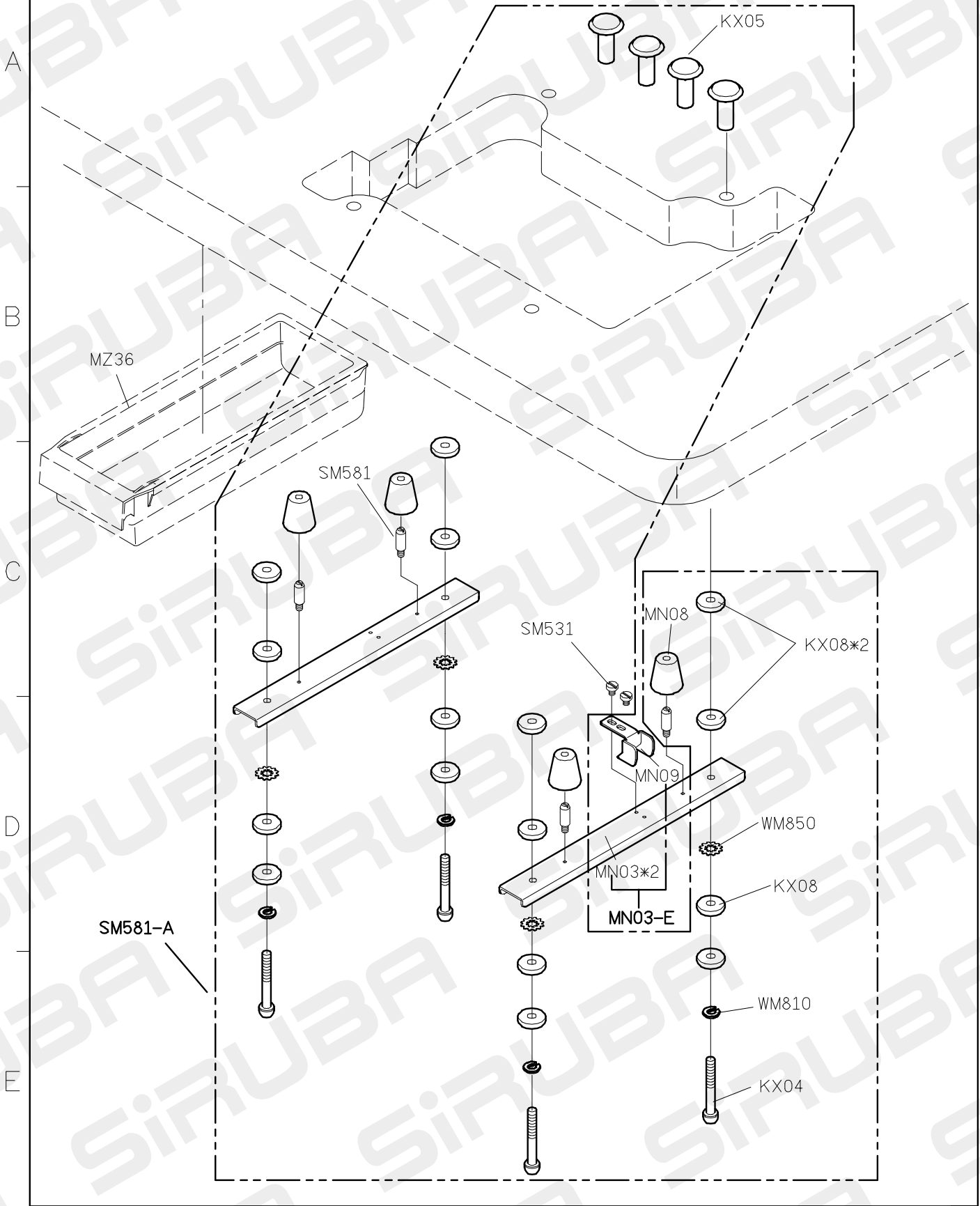

1
FOR C007J/C007JD/S007K/S007KD

2
3
4
5
3
10/05/20

C007JD PARTS LIST FOR MN GROUP P.2/2

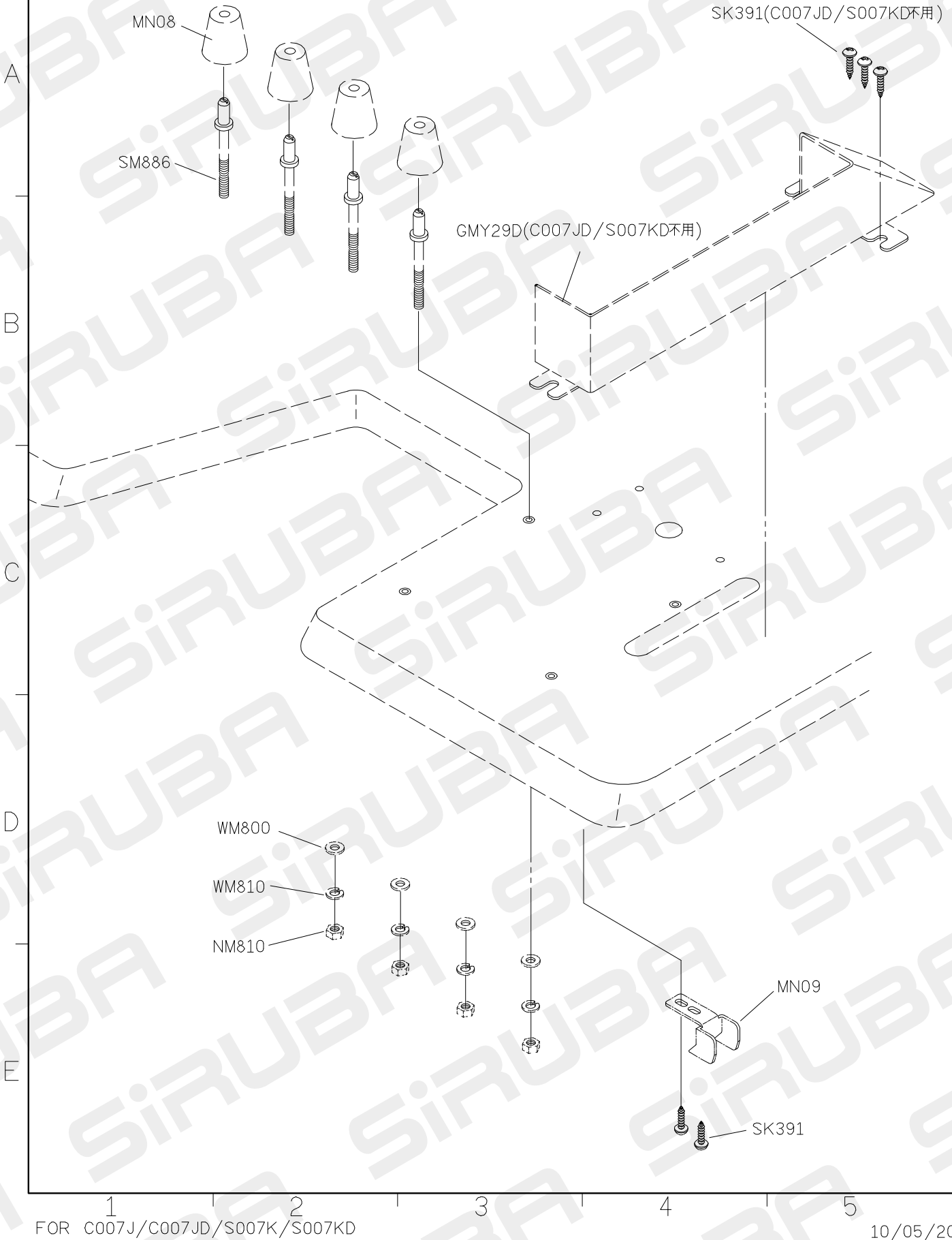

C007JD PARTS LIST FOR MQ-J GROUP P.1/1

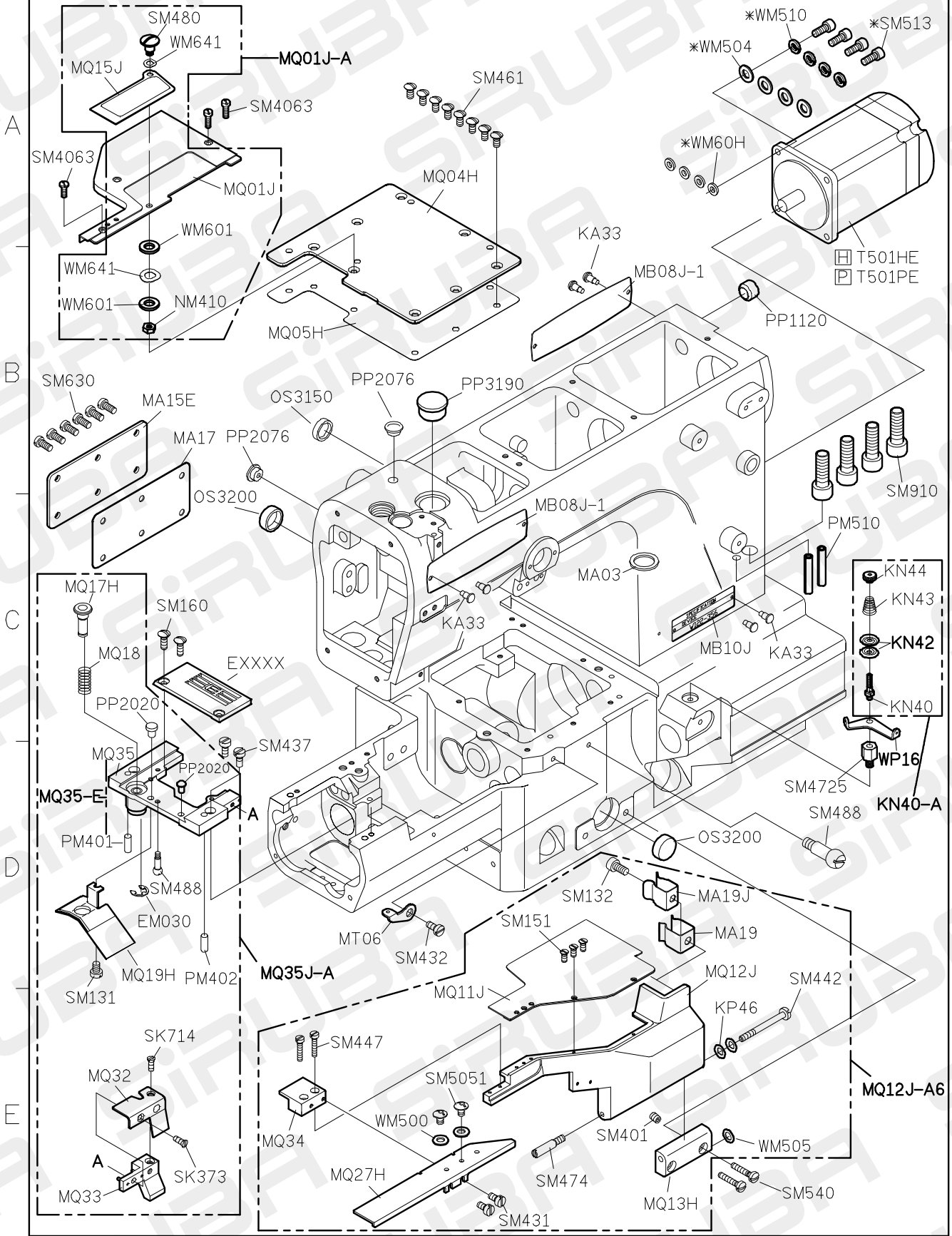

FOR C007J/C007JD/C858J/C858JD
 * USE FOR C007JD/C858JD

☐ FOR C007JD/C858JD H牌馬達
 □ FOR C007JD/C858JD P牌馬達

C007JD PARTS LIST FOR MR-J GROUP P.1/1

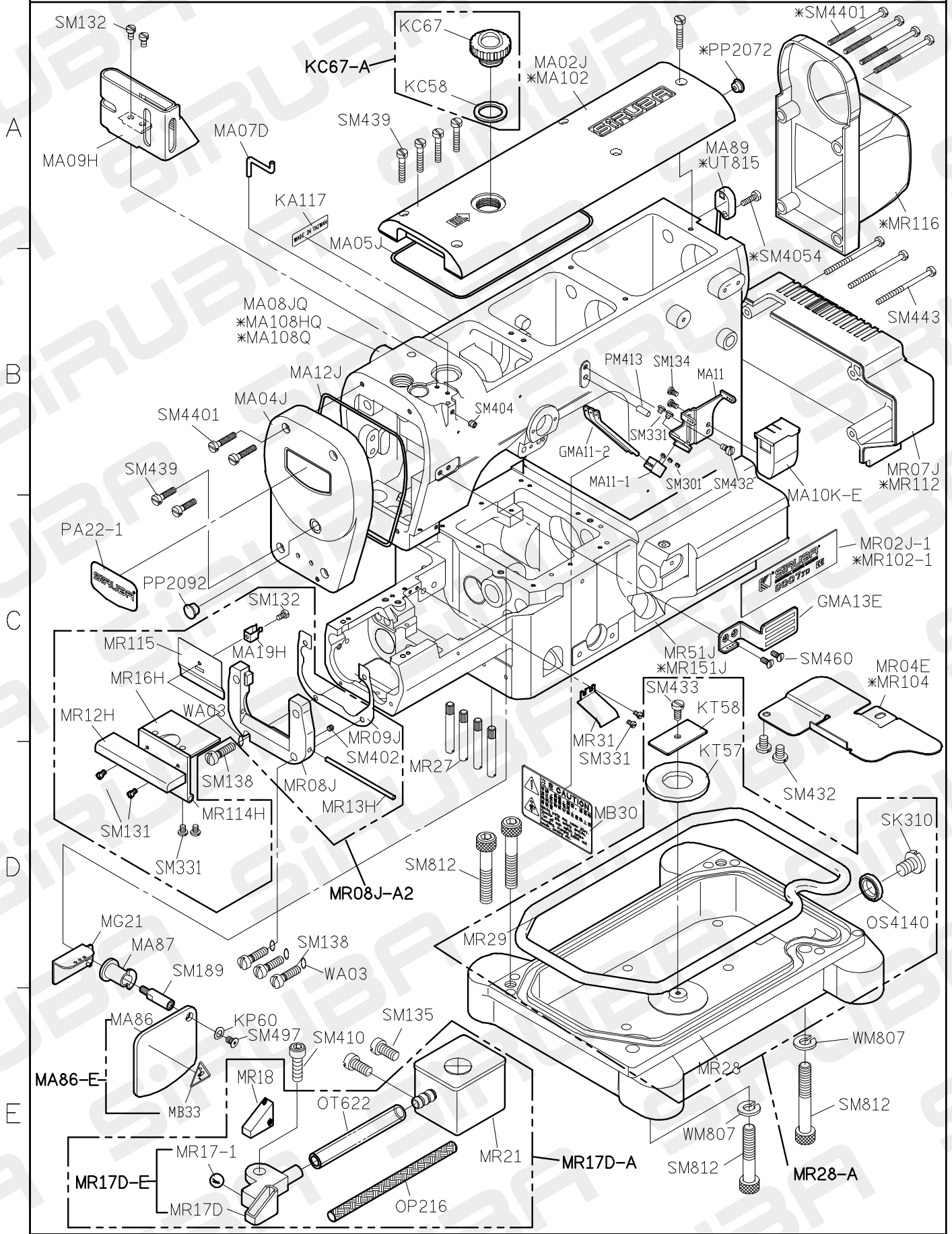

FOR C007J/C007JD/C858J/C858JD
 *USE FOR C007JD/C858JD

11/02/21

C007JD PARTS LIST FOR MS GROUP P.1/1

FOR C007J

MS08D-C1 = [A] + [B] + [C] + [D] + [E] + [F]

MS系列 MT系列 MU系列 MV系列

A

B

C

D

E

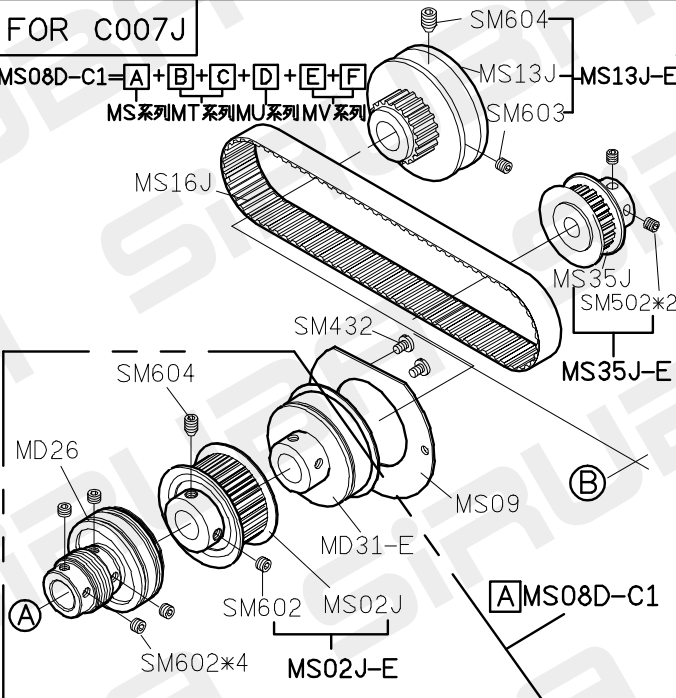

FOR C007JD

[A] MS108-C

[A]

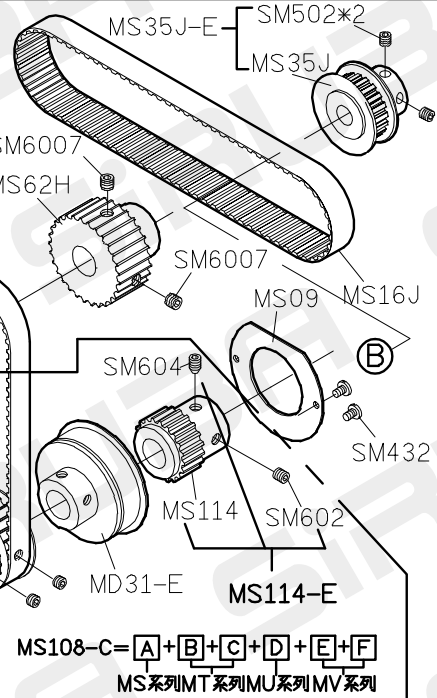

MS108-C = [A] + [B] + [C] + [D] + [E] + [F]
MS系列 MT系列 MU系列 MV系列

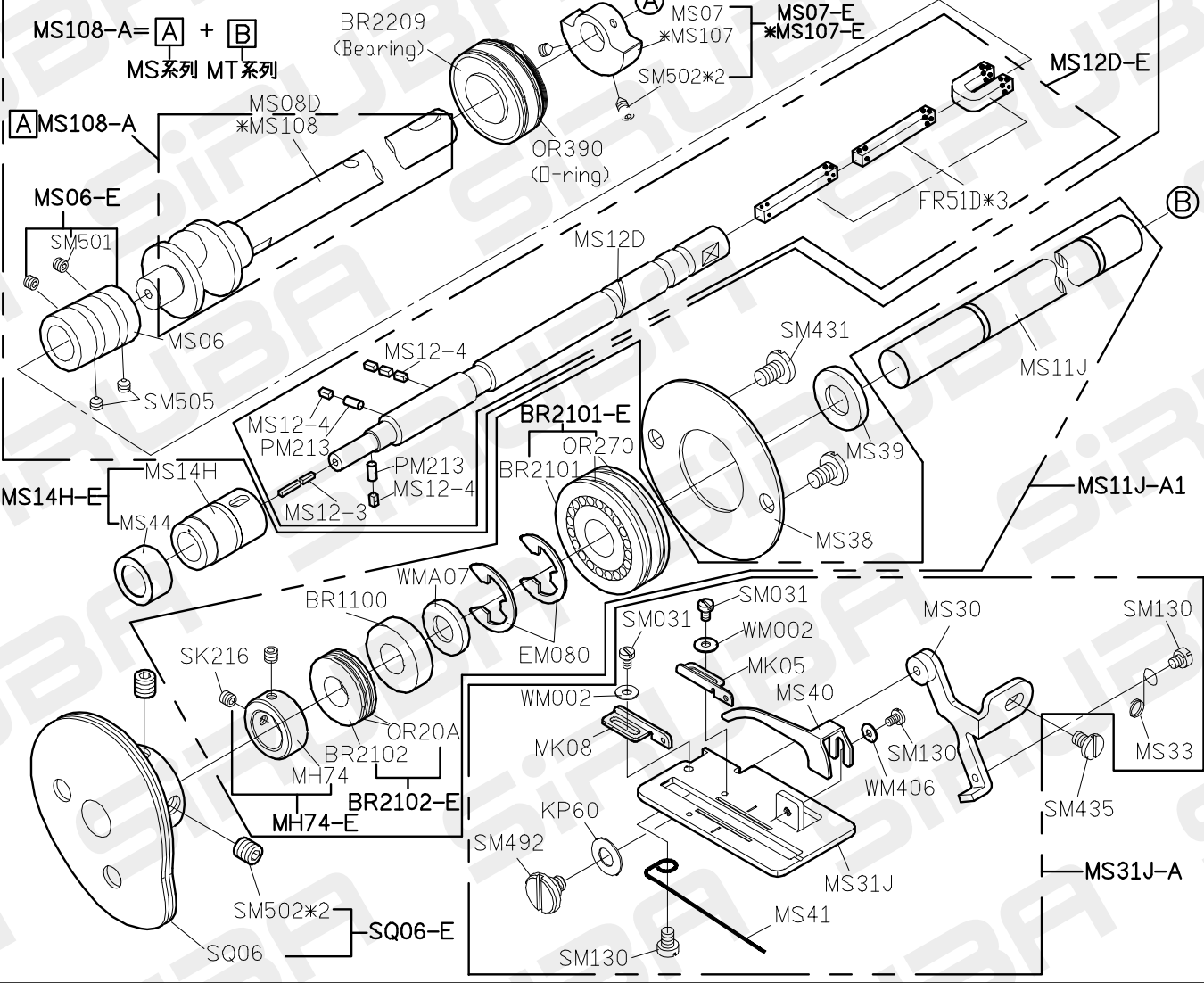

FOR C007J/C007JD/C858J/C858JD
*USE FOR C007JD/C858JD

10/05/20

C007JD PARTS LIST FOR MT GROUP P.1/1

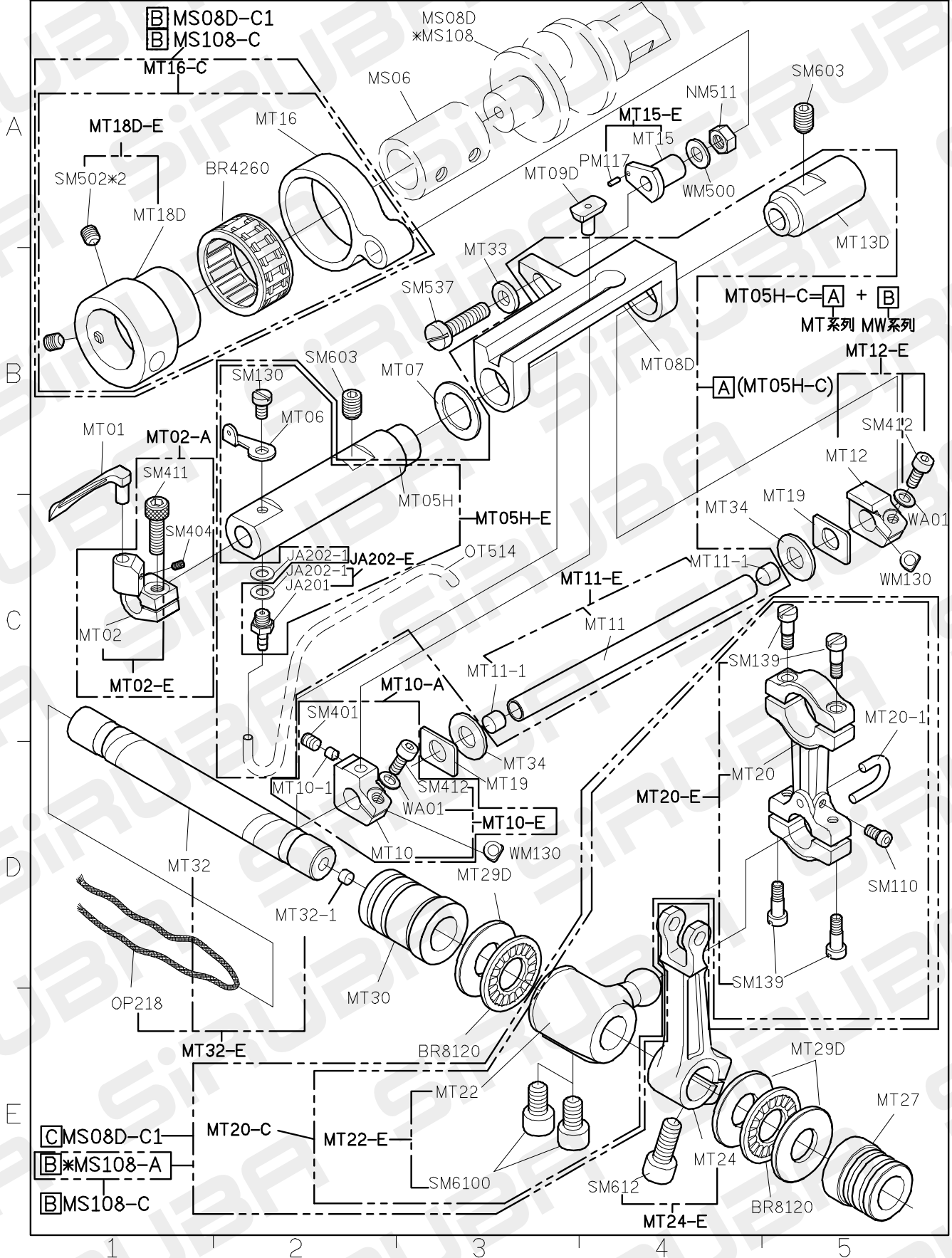

FOR C007J/C007JD/C858J/C858JD
 *USE FOR C007JD/C858JD

C007JD PARTS LIST FOR MU GROUP P.1/1

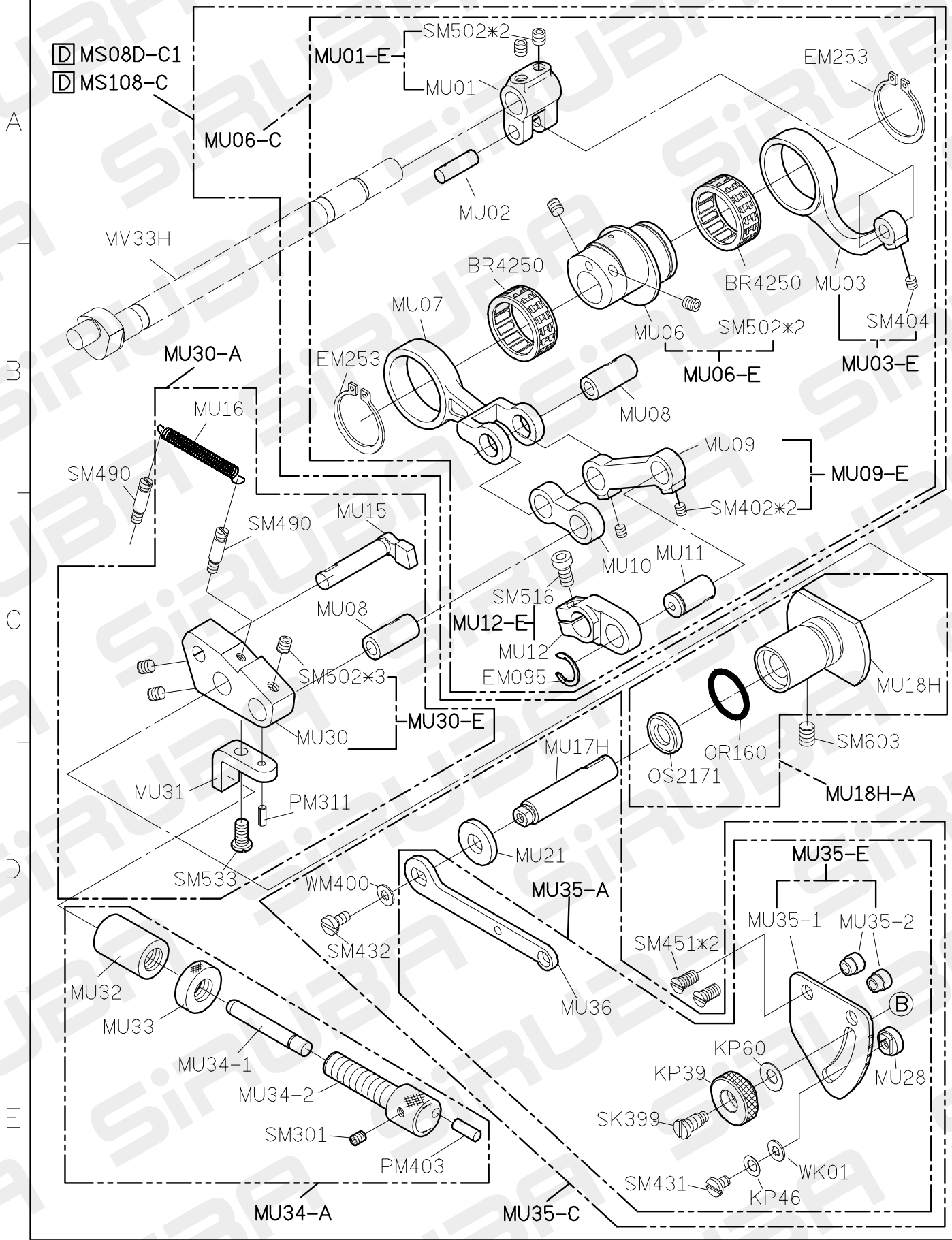

C007JD PARTS LIST FOR MV GROUP P.1/1

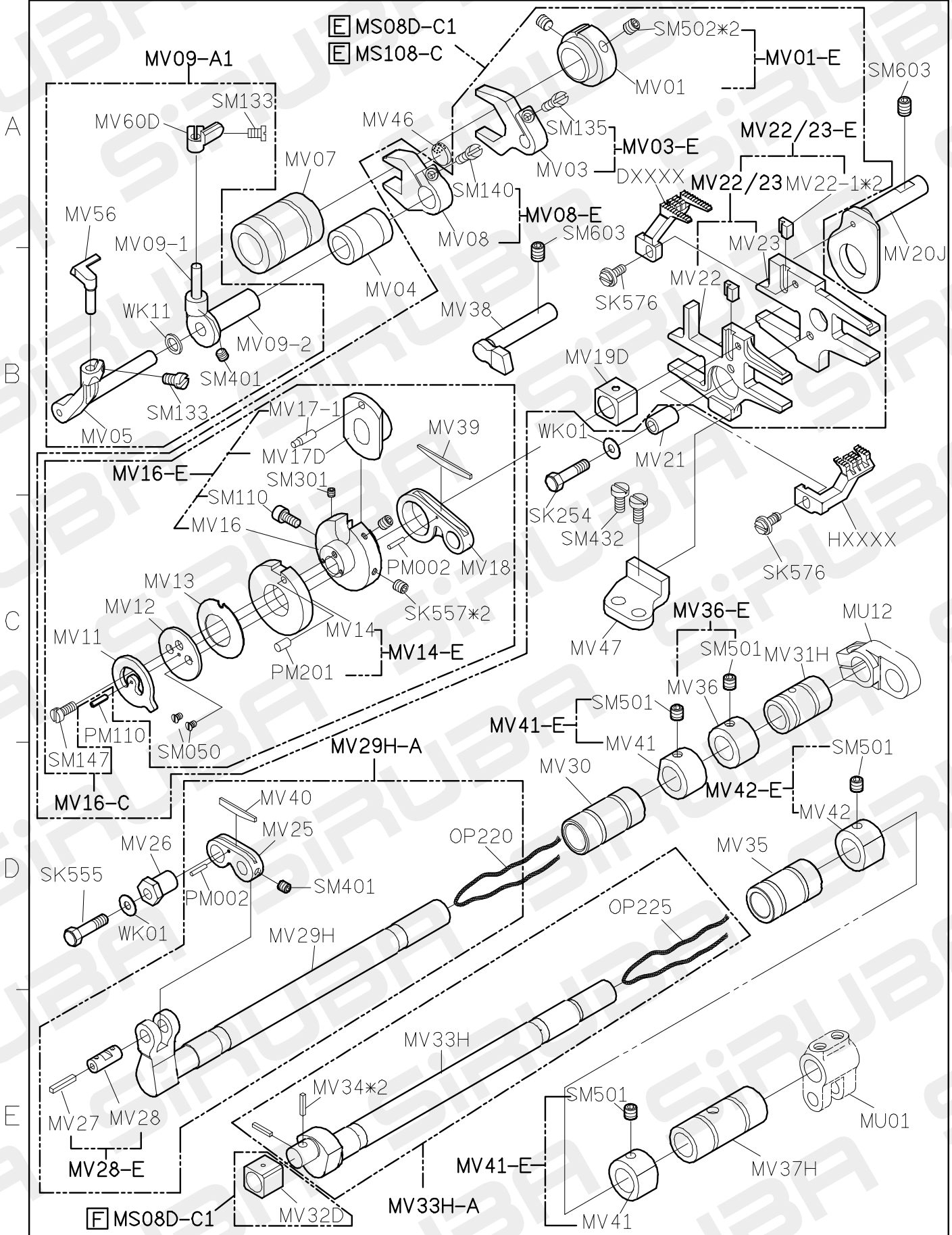

C007JD PARTS LIST FOR MW GROUP P.1/1

A

B

C

D

E

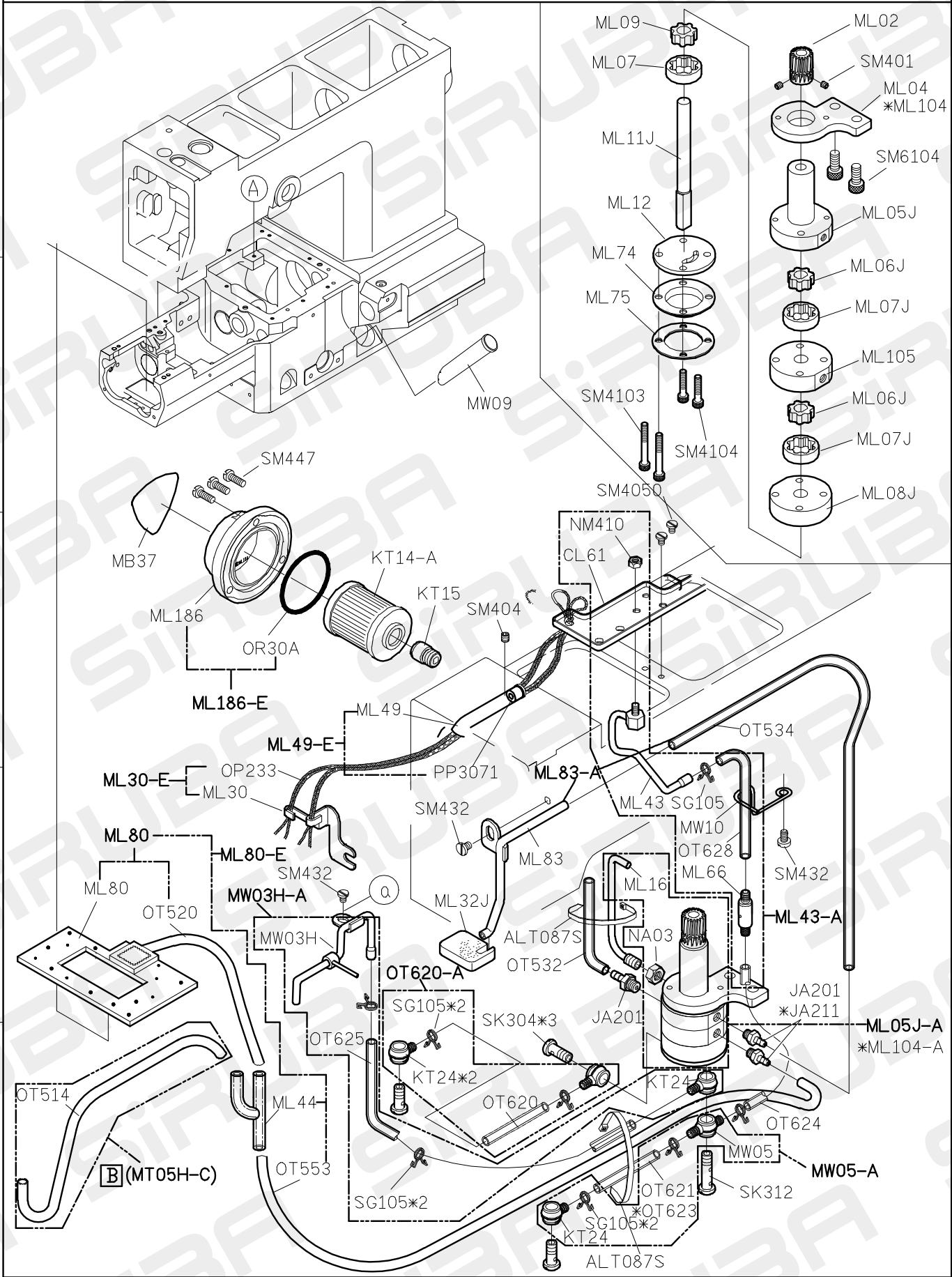

C007JD PARTS LIST FOR MY GROUP P.1/1

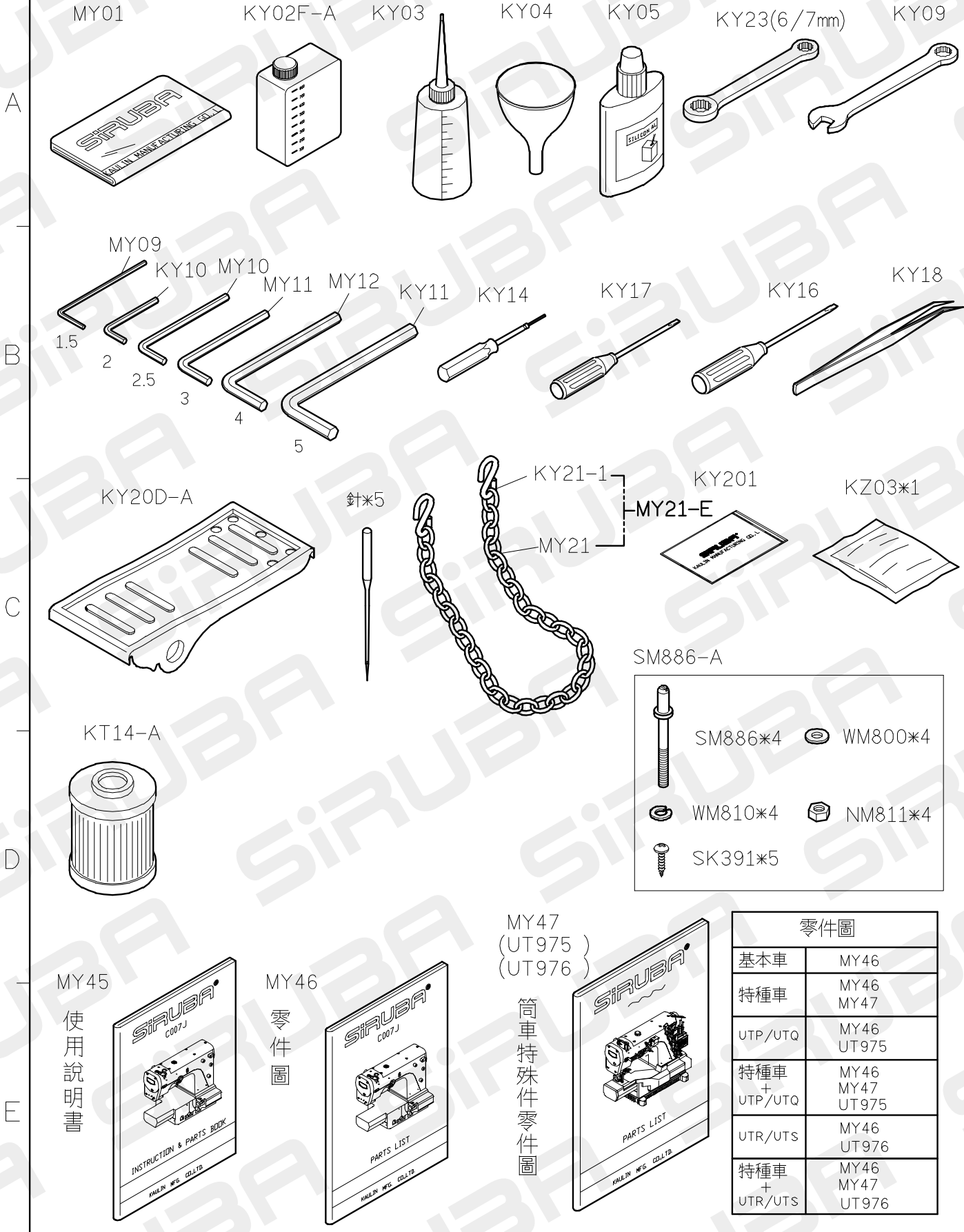

SM886-A

- SM886*4
- WM800*4
- WM810*4
- NM811*4
- SK391*5

零件圖	
基本車	MY46
特種車	MY46 MY47
UTP/UTQ	MY46 UT975
特種車 + UTP/UTQ	MY46 MY47 UT975
UTR/UTS	MY46 UT976
特種車 + UTR/UTS	MY46 MY47 UT976

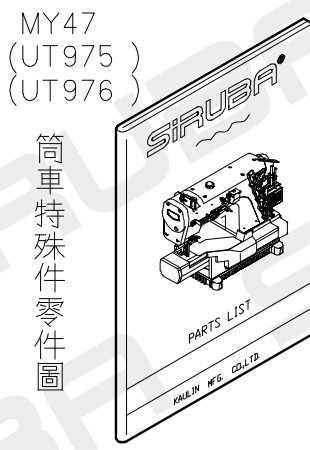
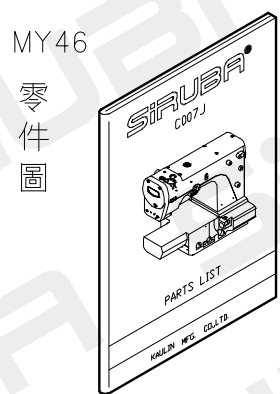
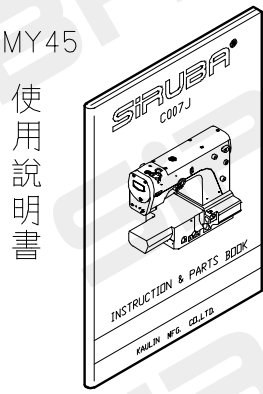

C007JD PARTS LIST FOR MZ GROUP P.1/1

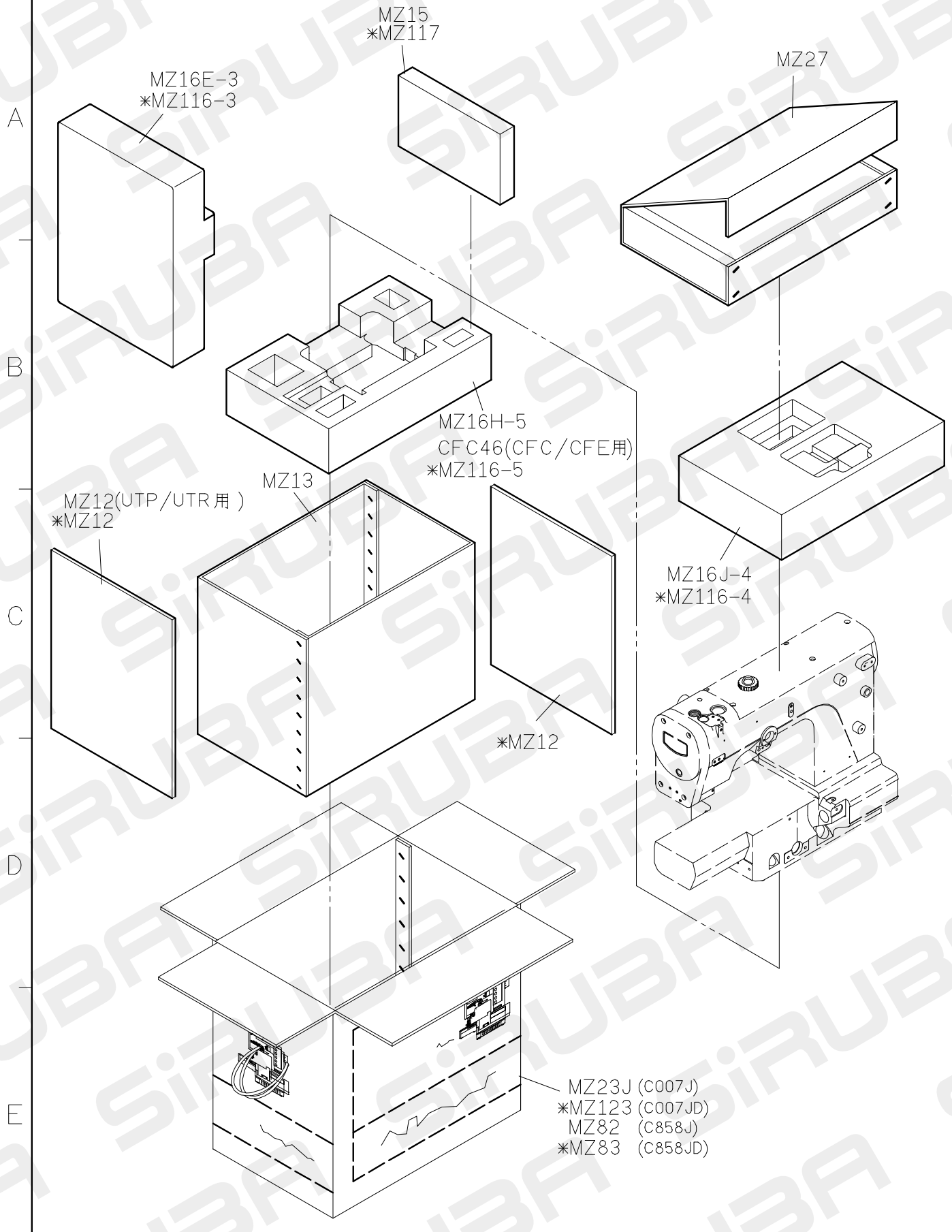

TABLE CUT-OUT OF C007-T22

三針筒車下乘桌板圖

C007J SERIES TABLE CUT-OUT SEMI-SUBMERGED

單位/UNIT:mm

FOR CRB

所有尺寸公差/DIFFERENCE:±2

C007-T22-1070長度(L):1070/重量:11.5kg±5%

C007-T22長度(L):1200/重量:12.5kg±5%

全封邊灰格紋光塑面台板

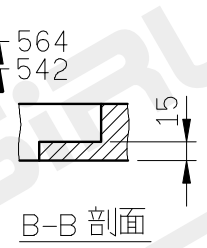
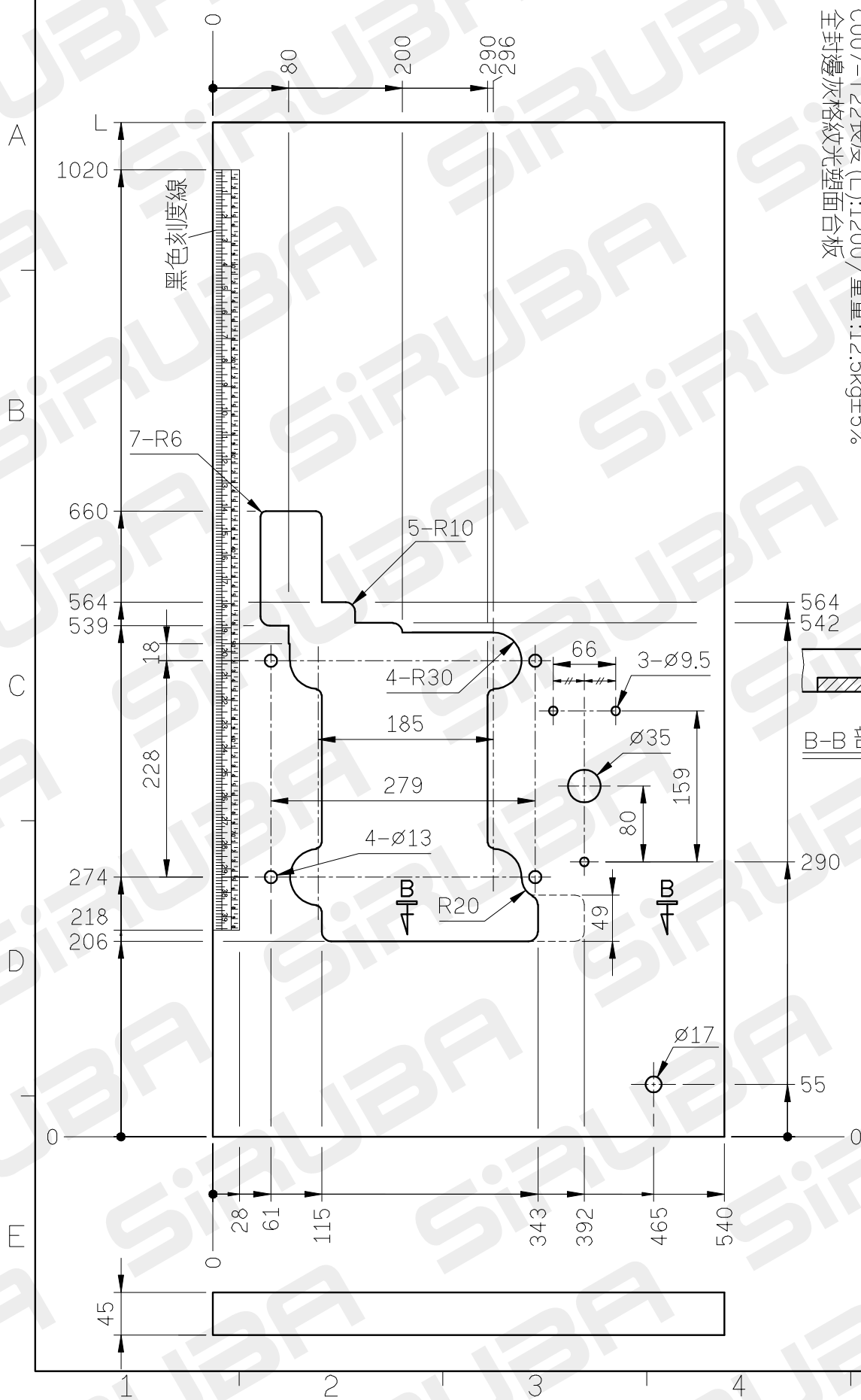

TABLE CUT-OUT OF C007-T23

三針筒車下乘桌板圖

C007J/C007JD/S007K/S007KD SERIES TABLE CUT-OUT SEMI-SUBMERGED

單位/UNIT:mm

FOR 一般車及自動切線

所有尺寸公差/DIFFERENCE:±2

C007-T23-1070長度(L):1070/重量:11.5kg±5%

C007-T23長度(L):1200/重量:12.5kg±5%

全封邊灰格紋光塑面台板

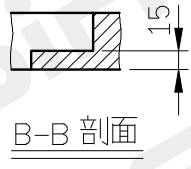
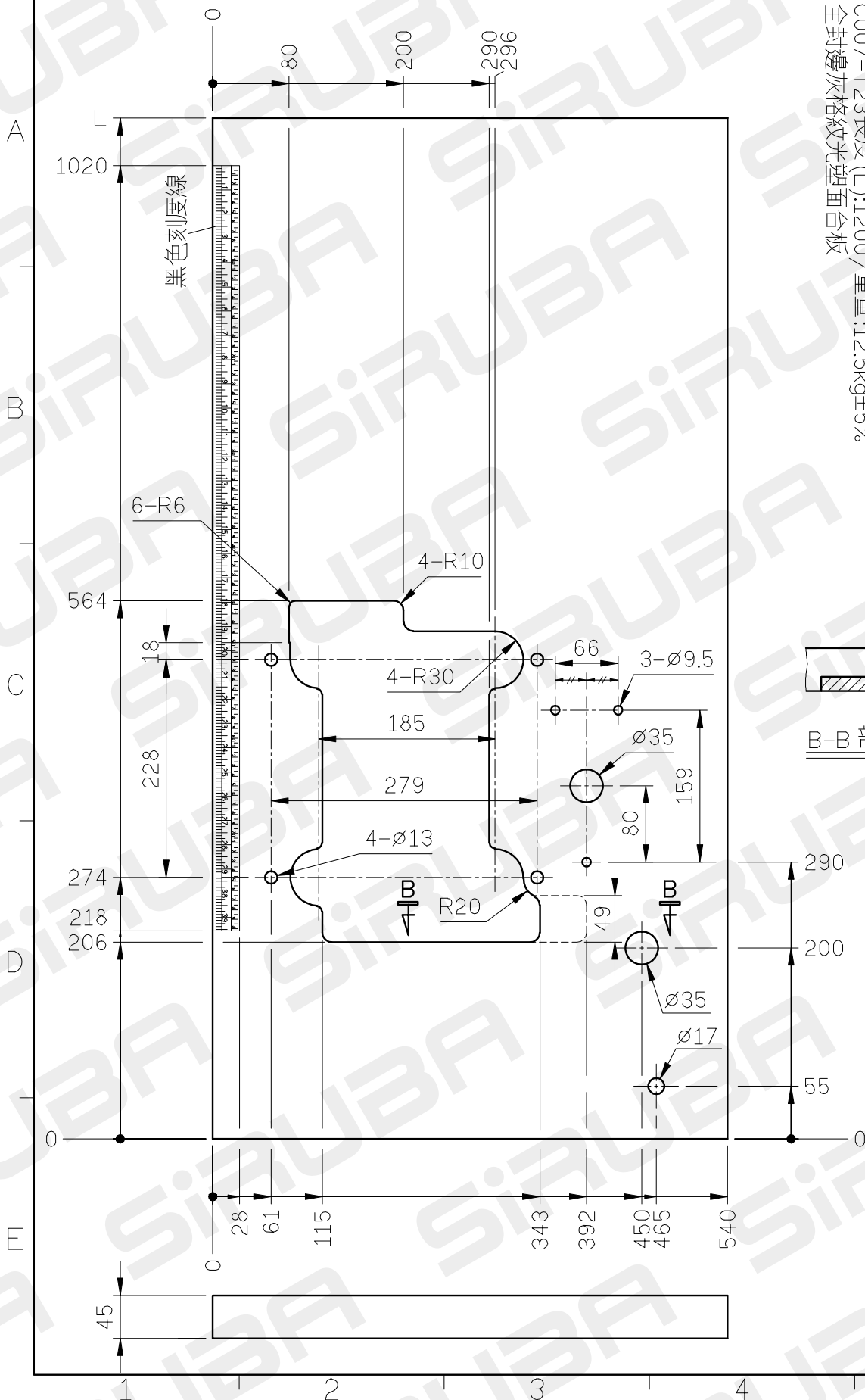

TABLE CUT-OUT OF C007-T24

三針筒車上乘桌板圖

C007J SERIES TABLE CUT-OUT SEMI-SUBMERGED

單位/UNIT:mm

FOR 一般車及自動切線

所有尺寸公差/DIFFERENCE:±2

C007-T24-1070長度(L):1070/重量:11.3kg±5%

C007-T24長度(L):1200/重量:12.3kg±5%

全封邊灰格紋光塑面台板

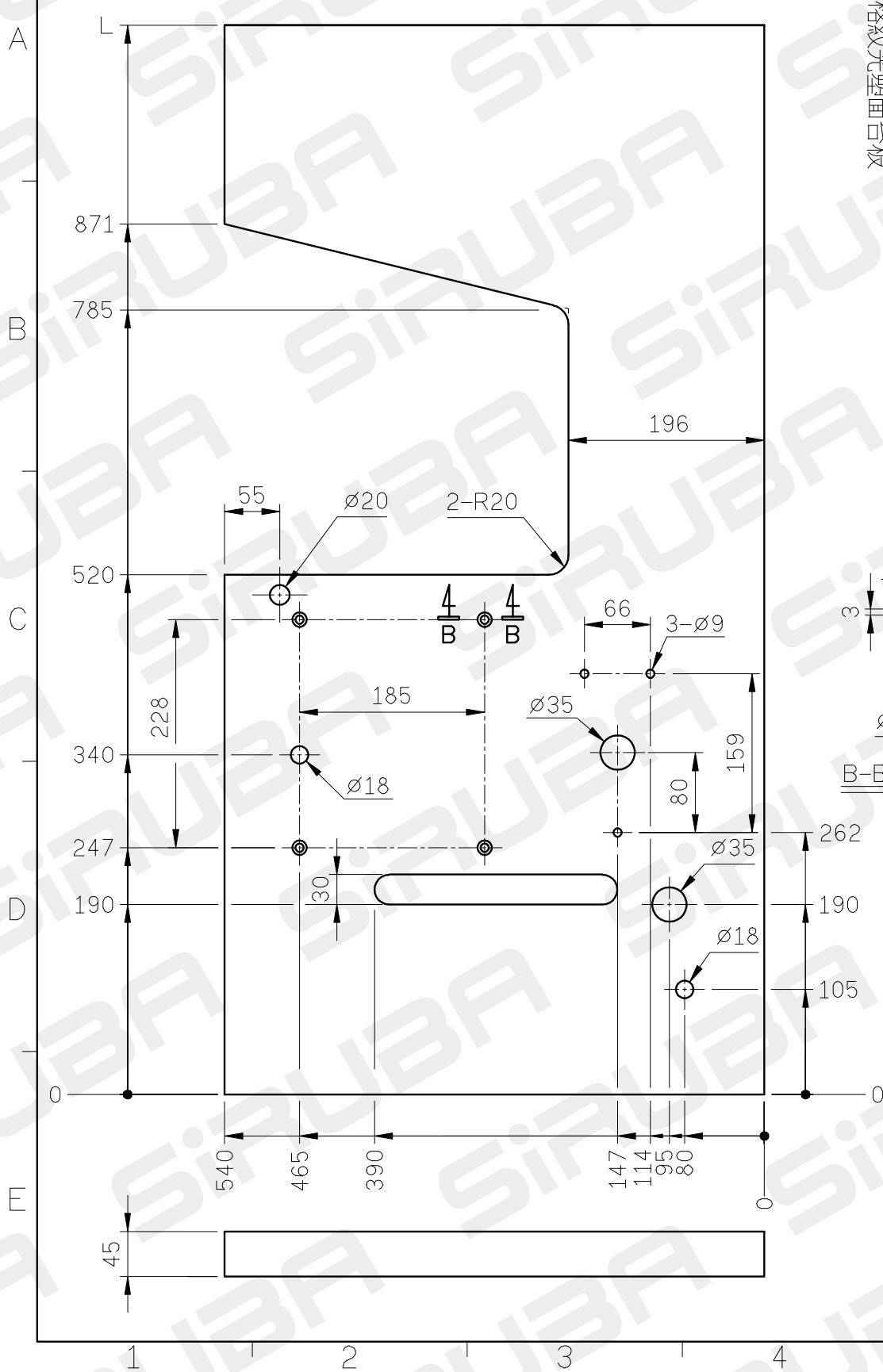

TABLE CUT-OUT OF C007-T25

三針筒車上乘桌板圖

C007J/C007JD/S007K/S007KD SERIES TABLE CUT-OUT SEMI-SUBMERGED

單位/UNIT:mm

FOR CRL:CRL/UTP:Q

所有尺寸公差/DIFFERENCE:±2

C007-T25-1070長度(L):1070/重量:11.3kg±5%

C007-T25長度(L):1200/重量:12.3kg±5%

全封邊灰格紋光塑面台板

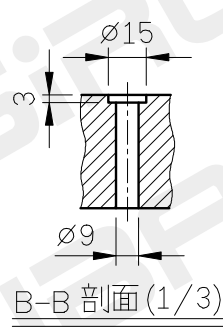
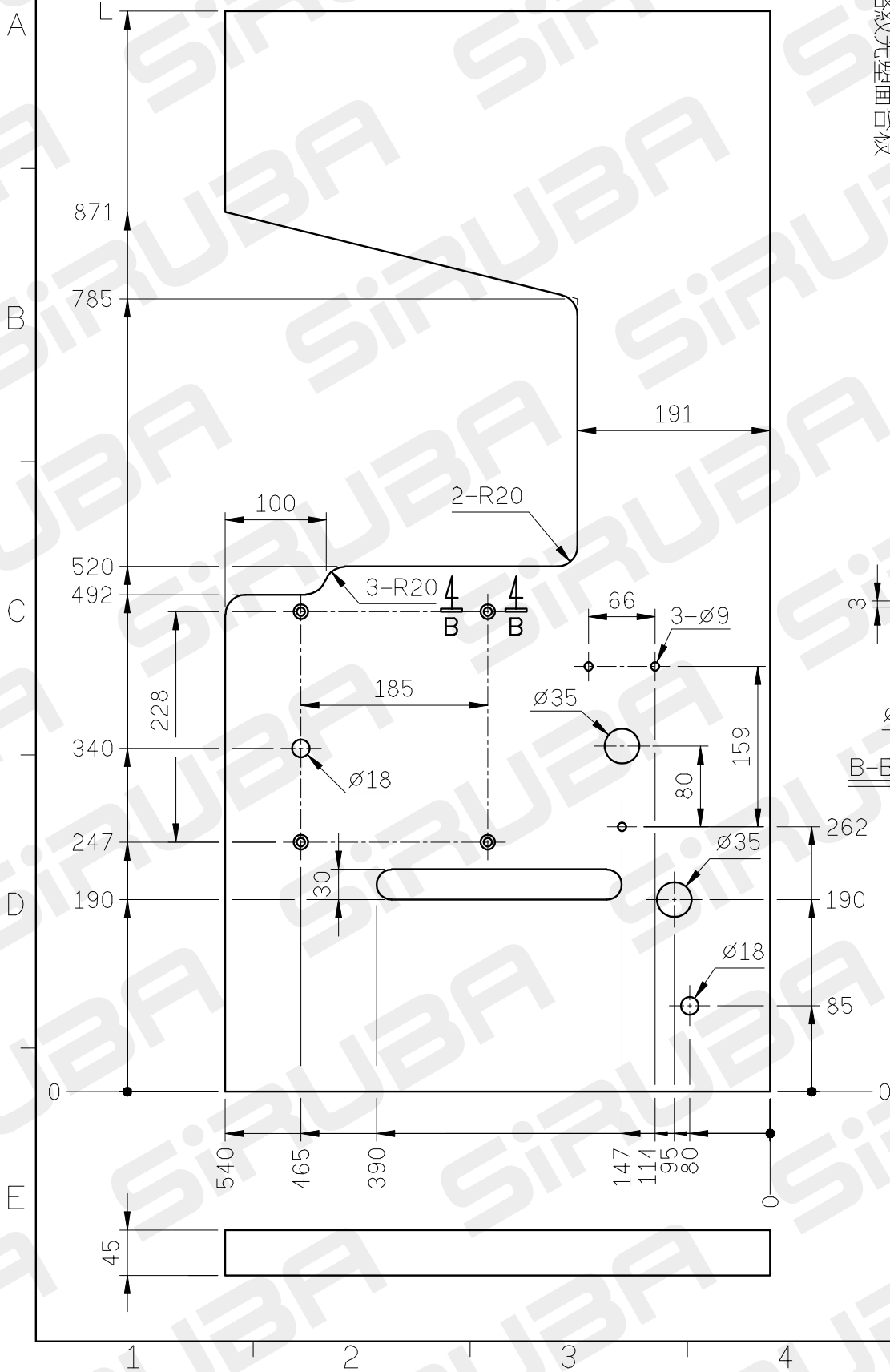

TABLE CUT-OUT OF C007-T26

三針筒車下乘桌板圖

C007J SERIES TABLE CUT-OUT SEMI-SUBMERGED

單位/UNIT:mm

FOR CFC/CFE

所有尺寸公差/DIFFERENCE:±2

C007-T26-1070長度(L):1070/重量:11.4kg±5%

C007-T26長度(L):1200/重量:12.4kg±5%

全封邊灰格紋光塑面台板

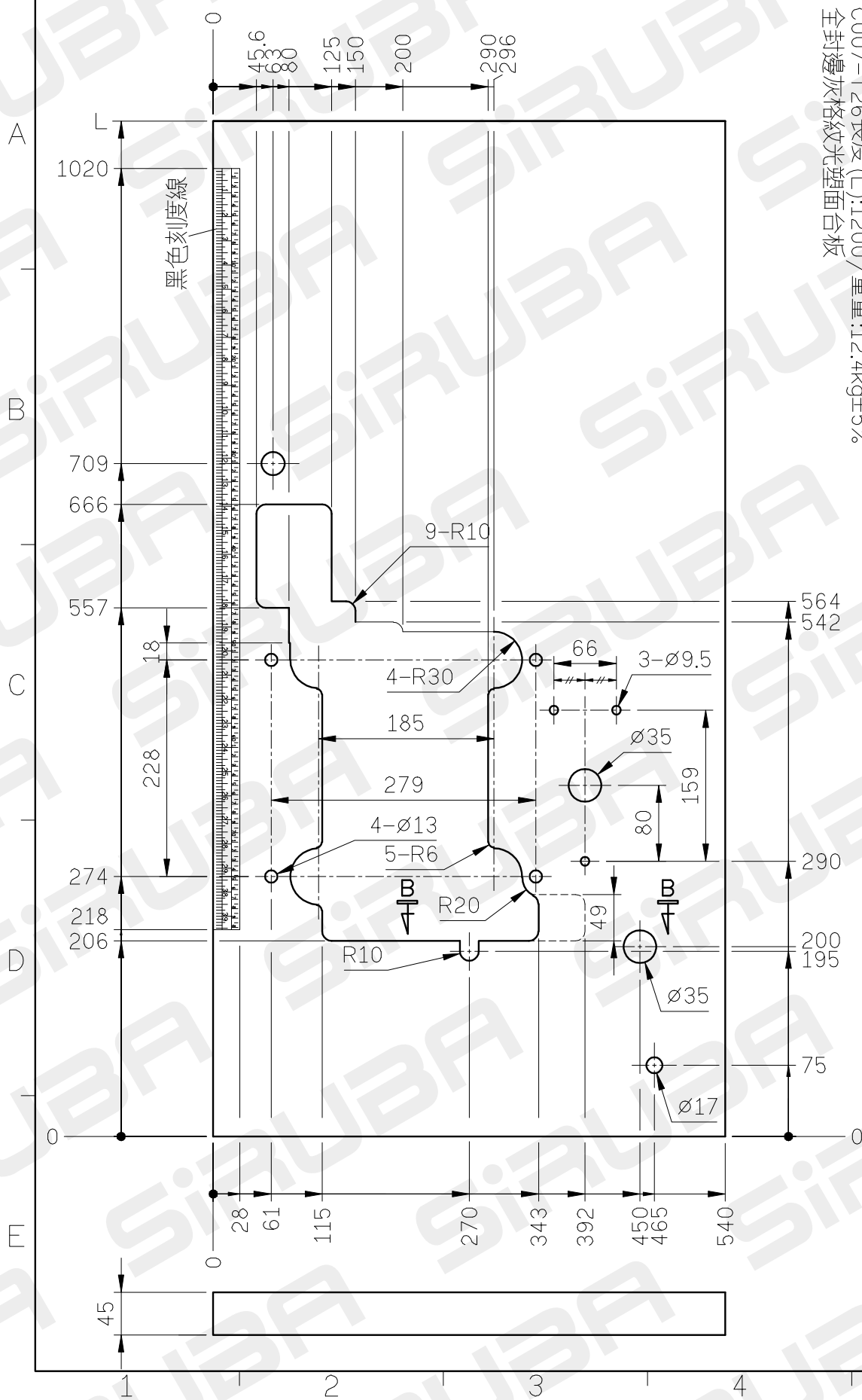

TABLE CUT-OUT OF C007-T30

三針筒車上乘桌板圖

C007 J SERIES TABLE CUT-OUT SEMI-SUBMERGED

單位/UNIT:mm

FOR 印度客戶使用

所有尺寸公差/DIFFERENCE:±2

C007-T30-1070長度(L):1070/重量:11.3kg±5%

C007-T30長度(L):1200/重量:12.3kg±5%

全封邊灰格紋光塑面台板

