

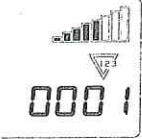



8		显示计件数时，按计数按键区域内   键，可对计件数当前值加减；
9		按计数复位键  可对当前显示的计数值清零。

386P0150

2014-4-14

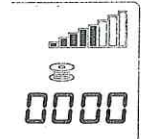
Motor controller

DT 8200

## Contents

1. Installation Introduction .....	1
1.1 Product specifications .....	1
1.2 Interface connection .....	1
2 Operation Panel Instruction .....	4
2.1 Operation panel display instruction .....	4
2.2 The operation panel keys of description .....	5
3 System parameter setting .....	9
3.1 Technician mode .....	9
3.2 Administrator mode .....	14
3.3 Monitoring Mode .....	20
3.4 Safety switch warning mode .....	20
3.5 False alarm mode .....	21
4 Special function operating instructions .....	22
4.1 Upper stop position adjust .....	22
4.2 A key recovery machine manufacturers parameter value .....	23
4.3 Pedal sensitivity adjustment .....	23
4.4 Electromagnet performance adjustment .....	24
4.5 Start/ end back tacking sewing mode set .....	25
4.6 Start/ end back tacking sewing and Four-segment sewing is set long needle .....	26
4.7 H-70 operating panel count needle number / piece number function	27

### Safety Instruction

- Please read this manual carefully, also with related manual for the machinery before use the controller.
- For installing and operating the controller properly and safely, qualified personnel are required.
- Please try to stay away from arc welding equipment, in order to avoid electromagnetic interference and malfunction of the controller.
- Keep in room bellow 45° and above 0°
- Do not humidity below 30% or above 95% or dew and mist of places.
- Install the control box and other components, turn off the power and unplug the power cord.
- To prevent interference or leakage accidents, please do the ground work, the power cord ground wire must be securely connected to an effective way to earth.
- All parts for the repair provided by the Company or approved before use.
- Performing any maintenance action, you must turn off the power and unplug the power cord. There are dangerous high voltage control box, you must turn the power off after one minute before opening the control box.
- This manual marked with the symbol of the Department of Safety Precautions must be aware of and strictly adhered to, so as not to cause unnecessary damage.

## 1. Installation Introduction

### 1.1 Product specifications

Product Type: AHU58A-55; AHD58A-55; Supply Voltage: AC 220 ± 20% V;  
Power frequency: 50Hz/60Hz; Maximum output power: 550W;

### 1.2 Interface connection

The foot pedal and the head of each connecting plug into the socket on the corresponding controller behind, each socket name as shown in Figure 1-2. Attached, please check whether the plug is inserted.

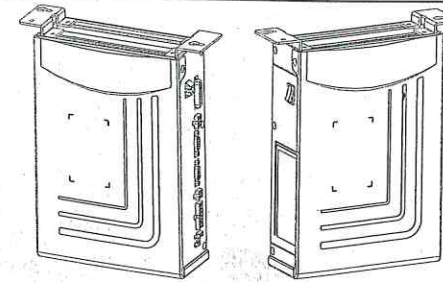

Fig.1-1 AS series Control Box

- ①:the motor power supply socket; ②: the pedal socket; ③:the motor encoder socket;  
④:the operation panel switch socket;⑤:the turn table;⑥:the automatic electromagnet socket; ⑦:the presser foot lifting electromagnet socket; ⑧:the head lamp socket (black); ⑨:the external synchronizer socket.

⚠: The use of the normal force are not inserted into the plug and socket, please check whether the matching, direction or needle insertion direction is correct! Lighting interface and presser foot lifting electromagnet interface is a 1\*2 interface, head lamp interface using black interface, please pay attention to the distinction between.

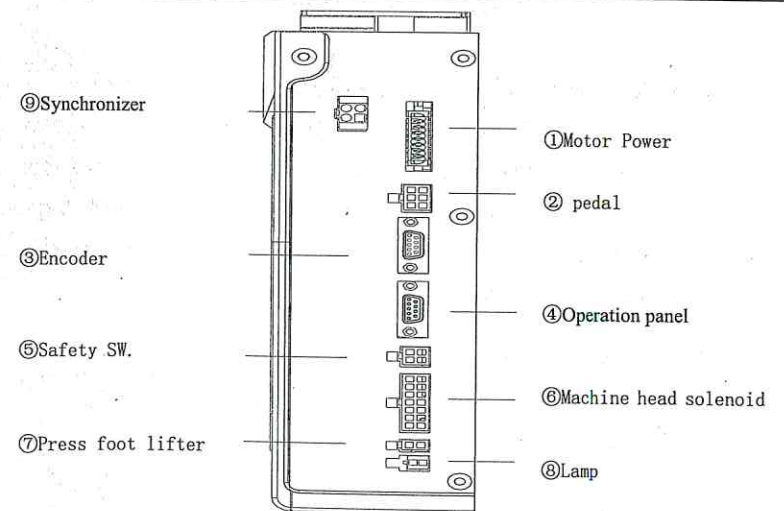

Fig.1-2 AH series control box outlet backplane

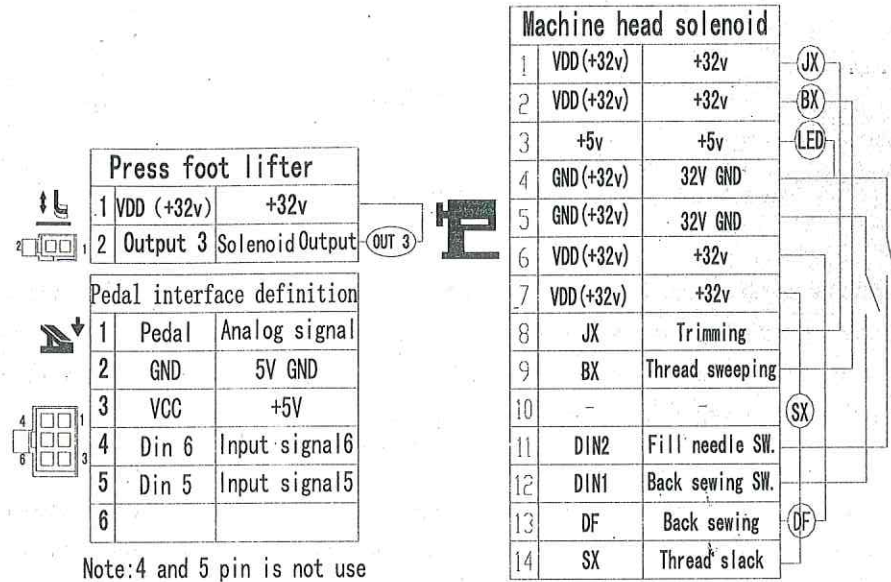

Fig.1-3 Controller interface definition

1.3 Power Connection and Grounding basic parameters

Please electrical engineer must do construction to the system grounding engineering. Electricity and put into use, must ensure that the power supply socket AC input has been safe and reliable grounding. System ground is yellow-green line, the line must be GNDed to the power grid safe reliable grounding protection, to ensure the safe use, and can prevent the abnormal situation.

⚠: All the power line, signal line, ground wire connection not by other objects or excessive pressure to distort, in order to ensure the safe use!

2 Operation Panel Instruction

2.1 Operation panel display instruction

According to the operating condition of the system, LCD module of operation panel will display the sewing patterns, various parameters, front / back fixed seam to set the current, and the presser foot, stop needle position, trimming thread, slow up the joint character of the LCD.

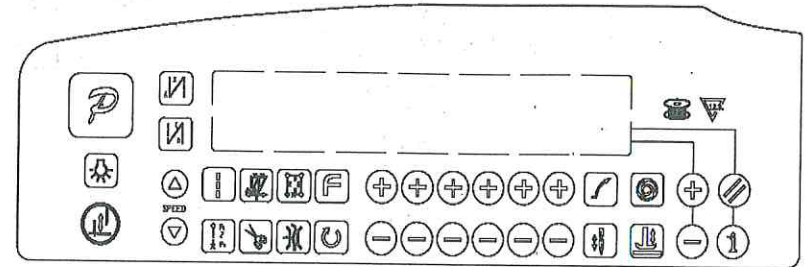

Fig.2-1 H-70 appearance

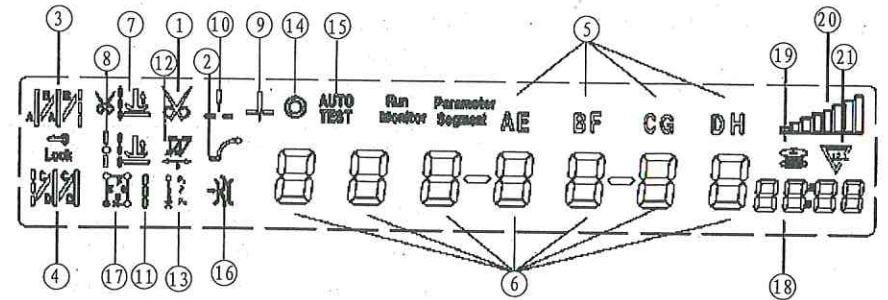

Fig.2-2 H-70 LCD screen icon

Table 2-1LCD Icon Display Description

Index	Icon	Description	Index	Icon	Description
①		Automatic trimming	⑫		W sewing
②		Soft-start function	⑬		Multi-segment sewing
③		start back tacking	⑭		Multi-seam trigger function
④		End back tacking	⑮		Automatic test
⑤		Sewing segments index	⑯		Clamp function















⑥		Numeric character display (pin number / parameter)	⑰		Four-segment sewing
⑦		Foot lifter after trimming	⑱		Count needle number
⑧		Middle stop foot lifter	⑲		Count piece number
⑨		Intermediate stops down stop position	⑳		Count display
⑩		Intermediate stops up stop position	㉑		Speed mark
⑪		needle and piece number of base line			









## 2.2 The operation panel keys of description

Table 2-2 Each key function introduction

No	Appearance	Name	Description
1		Function key	The key is parameters confirm key, and back to the previous menu until the operator sewing mode state. In addition, work with other key to set a higher level of the parameter.
2		Start back tacking key	It is called start back tacking function selection keys, every effective press the key once, system will be in accordance with the 11B parameter set none and single start back tacking  , double start back tacking  , four start back tacking  , LCD icon is lit at the same time. Show  is start back tacking interface, Select the corresponding  key and the  key can set needle(C, D) default range 1~F corresponds to the 1~15 pin.

No	Appearance	Name	Description
3		End back tacking key	It is called end back tacking function selection keys, every effective press the key once, system will be in accordance with the 11B parameter set none and single end back tacking  , double end back tacking  , four end back tacking  , LCD icon is lit at the same time. Show  is end back tacking interface, Select the corresponding  key and the  key can set needle(C, D) default range 1~F corresponds to the 1~15 pin.
4		Free sewing mode key	Press this key, the system into free sewing mode. LCD icon  is lit, step on the pedal to start sewing.
5		W sewing mode key	Press this key, system into w sewing mode, LCD icon  is lit, shown  is w sewing interface, Select the corresponding  key and the  key can set needle(A, B, D) default range 1~F corresponds to the 1~15 pin.
6		Multi-segment sewing mode key	It is called constant sewing, you press the key, the system enters to the multi segment sewing mode, LCD icon  is lit, shown  is multi-segment sewing interface,  is total segment, use  key and the  key to adjusting, the default maximum 24 segments,  is the current setting section,  as the sewing needle number of the current section, they are used  key and the  key to adjusting.
7		Four-segment sewing mode key	Press this key, system into the four segment sewing mode, LCD icon  is lit, shown  is four-segment sewing interface, Select the corresponding  key and the  key can set needle(E, F, G, H) default range 1~F corresponds to the 1~15 pin.

No	Appearance	Name	Description
8		Soft start key	Press this key, LCD icon  is lit, show soft start function effectively, then press the icon is off, indicates close soft start function.
9		Clamp string key	Press this key, LCD icon  is lit, show clamp function effectively, then press the icon is off, indicates close clamp function.
10		Stop position key	When sewing midway stop, system upper / lower needle stop position by pressing the key,  is lit, that is up needle stop position, then press the key,  is lit, show down needle stop. the sewing complete trimming, the system will stop up needle position. Note: the H-43 panel without the key, the key  +  combination to achieve the function.
11		Stitch compensation key	In the free sewing midway stop or multi segment sewing section stop, press the key can realize stitch compensate function. One shot the button to fill half needle, press a long time to fill a needle, keep the continuous stitch compensate.
12		Trimming key	Press this key, LCD icon  is lit, indicate that the automatic trimming function effectively, then press the icon is off, indicates close trimming function.
13		Press foot lifting key	Each press once, system presser foot model will not automatically presser foot, trimming back automatic presser foot  , sewing to automatic presser foot  , sewing end and stop press foot lifting four modes, corresponding LCD icon is lit up at the same time

No	Appearance	Name	Description
14		One-Shot-Sewing key	In the multi segment sewing mode, press the key, LCD icon is lit  , suggesting that trigger mode effectively, the pedal can be accomplished once the current period of setting needle sewing; then click the icon out, show that multi segment joint triggered off.
15		Lamp	H-43 and H-70 panel support machine headlight dimming function, in order to press the key, can get close and from dark to bright four stage light modulation effect.
16		Custom functions key	Custom extension function keys, and according to the situation can work with other key combination function
17		Speed increase and decrease key	The highest speed of system can be fast adjustment. In the multi segment sewing mode, also as the total segments of the adjust button. In addition, the parameter setting, can be used as keys corresponding to the adjustment parameter.
18		Parametric increase and decrease key	Adjust the parameter values increase and decrease
19		Switch key	Fast switching operation, the retention, not being used (H-43 panel without this key).
20		Counting switch key	Counting switch meter needle number model and the piece number model (H-43 panel without this key).
21		Count zero clearing key	Count needle mode and piece mode current count the clear button (H-43 panel without this key).

### 3 System parameter setting

#### 3.1 Technician mode

- 1、 Press **P** key and **↓** key can modify the technician parameter table.
- 2、 The LCD will display **P d-0000**. Type the password for the technician, the initial password is 0000, press the corresponding **+** key and the **-** key can change the password value;
- 3、 Press **P** key, If the password is correct, enter into the technician parameter setting mode, shown **100-0000**,
- 4、 Press the corresponding to **+** key and the **-** key, select the parameter and change the corresponding parameter.
- 5、 Press **P** key, exit parameter setting mode, return to sewing mode.

NO.	Range	Default	Description	Comment
100	100-800	200	Start sewing speed	Speed
101	200-5000	3500	Maximum sewing speed	
102	200-5000	3000	Maximum constant sewing speed	
105	100-500	250	Trimming speed	
107	1-9	2	Soft start stitch number	
108	100-800	200	Soft start speed	
110	200-2200	1800	Start back tacking speed	Back tacking Para.
111	200-2200	1800	End back tacking speed	
112	200-2200	1800	W-type sewing speed	
113	1-70	24	Start back tacking, No.1 stitch compensation profile	
114	1-70	20	Start back tacking, No.2 stitch compensation profile	
115	1-70	24	End back tacking, No.1 stitch compensation profile	
116	1-70	20	End back tacking, No.2 stitch compensation profile	
11A	10-359	170	Stitch compensation reference angle(optimum actuation angle of backstitch electromagnet)	

11b	0-4	0	Start and end back tacking type (CD and AB) 0: B->AB->ABAB->none 1: B->none 2: B->AB->none 3: AB->none 4: AB->ABAB->none		
11c	0000-9999	0	Corresponding to A/B/C/D pins of ten bit, start and end back tacking interface under the A/B/C/D digits together constitute the two digit pin number, each section of pin number 1-99 needle.		
11d	0000-9999	0	Corresponding to E/F/G/H pins of ten bit, start and end back tacking interface under the E/F/G/H digits together constitute the two digit pin number, each section of pin number 1-99 needle.		
130	0/1/2/3	2	Pedal speed-control profile mode: 0: Auto linear ramp (auto calculation according to max. speed) 1: Two segment liner Curve. 2: Power law curve 3: S-type curve	Pedal Para.	
131	200-4000	3000	Sub-Para. Of two-stage speed control: mid-turning-point speed RPM (two-stage ramp turning point speed)		
132	0-1024	800	Sub-para. Of two-stage speed control ramp: Pedal analog value of mid-turning-point (in 138 to 139 parameters)		
133	1/2	1	Sub-para. Of power speed control curve: 1: Square 2: Radiation		
134	0-1024	90	Trimming pedal-position		Figure 4-1shows the specific setting method.
135	0-1024	300	Foot lifting pedal-position		
136	0-1024	460	Pedal back to Mid position		
137	0-1024	480	Pedal start running position		
138	0-1024	580	Pedal low speed running position		
139	0-1024	962	Pedal max. Analog value		
13A	0-800	100	Pedal foot lifting confirming time		









13C	0/1	1	Foot lifting position, foot lifting function selection: 0: without 1:with	Customize Set up
13E	1-800	0	Trimming after, foot lifting delay time (clamp)	
140	0/1	1	Run to up needle position after Power on : 0: no action 1: action	
141	0/1	1	Automatically reinforcing functions chose : (the machine head is not automatically reinforcing functions, the best way is prohibit) 0: prohibit 1: allow	
142	0/1	0	Function mode selection when manually push back tacking 0: Juki mode. During sewing or stop sewing both have this action. 1: Brother mode. Only acts during sewing.	
143	0/1/2/3	0	Special operation mode: 0: Operator selection 1: Simply sewing mode 2: Motor initial angle measurement (not necessary to remove the belt) 3: Ratio mode calculation (synchronize encoder is necessary and belt can not be removed)	
144	0-31	0	Motor torque increase function in low speed on & off: 0: Normal functions 1-31: low speed torque increase level	
148	0/1/2	0	Fill needle mode: 0: the time control; 1: fill half needle; 2: fill a needle	
149		0	The presser foot lowering speed slowed down: slow release delay coefficient, bigger down more slowly	
14R	0-10	0	Pedal acceleration curve filtering coefficient	
150	1~100	1	Stitch counting proportion set up	
151	1~9999	1	Stitch counting value set up	

152	0~4	0	Stitch counting mode selection: 0: no counting 1: Counting up according to stitch number, after reaching set value then restart. 2: Counting down according to stitch number, after reaching set value then restart. 3: Counting up according to stitch number, after reaching set value ,motor automatically stop, by the reset button set or the P key on the panel to start counting again. 4: Counting down according to stitch number, after reaching set value ,motor automatically stop, by the reset button set or the P key on the panel to start counting again. 5: Counting up according to stitch number, after reaching set value ,alarm, motor lock after trimming thread. 6: Counting down according to stitch number, after reaching set value ,alarm, motor lock after trimming thread.	Count Mode			
			153		1~100	1	Cunting piece proportion set up
			154		1~9999	1	Counting piece value set up
155	0~4	0	Trimming counting mode selection: 0: no counting 1: Counting up according to piece number, after reaching set value then restart. 2: Counting down according to piece number, after reaching set value then restart. 3: Counting up according to piece number, after reaching set value, motor automatically stop, by the reset button set or the P key on the panel to start counting again. 4: Counting down according to stitch number, after reaching set value, motor automatically stop, by the reset button set or the P key on the panel to start counting again.				

156	0~9999	0	Corresponding to 1/2/3/4, an electromagnet chopper duty time selection (0 in MS, 1 in 0.1ms)	
157	0~9999	0	Corresponding to 5/6/7/8, an electromagnet chopper duty time selection (0 in MS, 1 in 0.1ms)	
158	0~1	0	Counting adjustable switch (gauge needle number and piece number (0) adjustable, 1 non-adjustable)	
161	0/1/2		Para. transmission method: 0: no action; 1: Para. Download (from operation panel to controller); 2: Para. Upload (from controller to operation panel).	Operation
162	1,2		Recover to default para.	
163	1,2		Save current para. As User custom para.(recoverable)	
164	-		Password	
165	-		Recovery controller factory parameters, and covering the head factory parameter or user defined mechanical parameters. The original parameters can not be restored.	

Note: Such "16x" parameter to operate is saved, you need press  key, about 3-5 seconds, it is saved.

### 3.2 Administrator mode

- 1、 Press  key and  key can modify the administrator parameter table.
- 2、 The LCD will display  $P \text{ d-0000}$ . Type the password for the administrator, the initial password is 0000, press the corresponding  key and  key can change the password value;
- 3、 Press  key. If the password is correct, enter into the administrator parameter setting mode, shown  $200-0000$ ,
- 4、 Press the corresponding to  key and  key, select the parameter and change the corresponding parameter.
- 5、 Press  key, exit parameter setting mode, return to sewing mode.

NO.	Range	Default	Description	Comment
200	0/1/2	0	Trimming motor operation mode selection: 0: flat sewing machine 1: interlock machines ( ordinary flat seaming shearing line: stop to the needle position after the trimming ) 2: The over-lock type: manual trimming	
202	0/1/2/ 3/4/5/ 6	1	Trimming time sequence selection: 0: The parameter 203 set angle[TS] start trimming, until the parameter 206 upper needle stop position is reached, then time delay to [T2] set value. 1: The parameter 203 set angles [TS] start trimming, until the parameter 204 set [TE] angle. 2: The parameter 203 set angle [TS] start trimming, time delay to the parameter 206 set [T2] value. 3: After lower needle stop position is reached, time delay to the parameter 205 set value [T1] then start trimming, time delay to the parameter 206 set value [T2].	Trimming Mode



			<p>4: After upper needle stop position is reached, time delay to the parameter 205 set value [T1] then start trimming, time delay to the parameter 206 set value [T2], most applications are for interlock machines.</p> <p>5: find the needle position signal started first stop pin stop tangent action. Tangent time delay [T2] and 205 parameters of the set time [T1] after the 206 parameter set. (most generally used for car models, while T1 and T2 setting value most are set to 0)</p> <p>6: 203 parameters that are set at [TS] of the tangent, Toshiba first stop pin stop. Tangent time delay [T2] and 205 parameters of the set time [T1] after the 206 parameter set.</p>	
203	5-359	10	Trimming start angle TS (relate to down needle stop position angle)	
204	10-359	120	Trimming finish angle TE (relate to down needle stop position angle, the value should be bigger than TS).	
205	1-999	10	Trimming start time delay T1 (ms)	
206	1-999	120	Trimming finish time delay T2 (ms)	
20A	10-60	20	trimming force coefficient (motor force)	
210	0 / 1 / 2 / 3 / 4 / 5 / 6	0	<p>Thread slack electromagnet sequential selection:</p> <p>0: 211 parameter set point of [LS] after loose line, until the needle position to delay 214 parameter set time [L2].</p> <p>1: 211 parameter set point of [LS] after loose line, until the 212 parameter set angle [LE].</p> <p>2: 211 parameter set point of [LS] after loose line, 214 parameters set by the [L2] until the time delay.</p> <p>3: bit signal delay [L1] set the time to loose line, 214 parameters set by the [L2] until the time delay.</p>	

			<p>4: needle position signal delay [L1] set the time to looseline, 214 parameters set by the [L2] until the time delay.</p> <p>Under 5: bit signal started loose line first stop pin stop. Then the delay parameter 213 set time [L1] after the 214 parameter set loose line time [L2].</p> <p>6: 211 parameter set point of [LS] after loose line, first stop pin stop. Then the delay parameter 213 set time [L1] after the 214 parameter set loose line time [L2].</p>	
211	5-359	25	Thread slack electromagnet start angle LS (relate to down needle stop position angle)	Thread slack/
212	10-359	350	Thread slack electromagnet finish angle LE (relate to down needle stop position, the value should bigger than LS)	Thread sweeping/
213	1-999	1	Thread slack electromagnet start time delay T1 (ms)	String nipping Mode
214	1~999	10	Thread slack electromagnet time delay T2 (ms) after upper needle stop position is reached	
215	0 / 1	1	String sweeping function selection 0: off 1: on	
216	1~999	10	Thread wiping/Thread sweeping time delay ms	
217	1~9999	70	Thread wiping/Thread sweeping time delay ms	
218	1~999	50	Thread wiping/Thread sweeping recover time ms	
219	0 / 1	0	Thread nipping function selection 0: off 1: on	
21A	10-359	120	Thread nipping initial angle	
21b	11-359	318	Thread nipping finish angle	
21E	11-359	160	Lower angle after foot lifting when thread nipping	
220	200~360	360	Stop position after trimming (can implement pull back function after trimming)	

224	0/1/2/3	0	Emergency Stop Mode: 0: Turn off the emergency stop function 1: Emergency stop at any position 2: Emergency stop at upper needle stop position 3: Emergency stop at lower needle stop position	Stop Mode
225	0~999	0	Continue stitch No. before emergency stop (according to different set speed and stitch No., the actual value might be bigger)	
226	0/1	0	Restart after emergency stop: 0: Can not be restart, it's necessary to restart the power. 1: When the alarm is canceled, can be restarted.	
231	0/1	0	Auto test mode selection: 0: With certain stitch number 1: With certain time	
232	0~1000	300	Safety alarm confirming time ms (for flat sewing machine safety tilting switch and overlock sewing machine safety knife protection switch are same, use the same solution)	
233	0~1000	50	Safety switch recover confirm time ms	Machine Para.
234	0/1	0	Motor resolving direction: 1: C.C.W 0: C.W.	
240	0~9999	1000	Motor/machine ratio:0.001 (If ratio has been calculated automatically, the para. In the controller might be different with HMI)	
241	-	-	Retain	
242	0~359	0	Adjustment angle of upper needle stop position (relate to angle difference of upper needle stop position encoder)	
243	0~359	175	Mech. Angle of lower needle stop position	
244	0~800	200	Foot lifting release time delay (ms)	
245	0~359	9	Torque increase initial angle of over thick material	
246	0~359	57	Torque increase finish angle of over thick material	

247	0~2000	0	Oil refill time alarm (hour. 0: function deactivated)	Input function definition
248	0~4000	0	Oil alarm, stop operation time (hour. 0: function deactivated)	
250	As follows	1	No.1 input definition	
251		1	No.1 active input level 0/1	
252		0	No.2 input definition	
253		0	No.2 active input level 0/1	
254		0	No.3 input definition	
255		0	No.3 active input level 0/1	
256		0	No.4 input definition	
257		0	No.4 active input level 0/1	
250	0:Disable 1:Manual back tacking 2:Safety switch 3:Emergency stop 4:Material side detection 5:Pedal trimming input 6:Pedal foot lifting input 7:Stitch compensation 8:Front-end/rear-end back tacking reverse 9:Presser foot alternation lifting 10:Air-tight joint 11:Counter reset 12:OP input 13:Presser foot alternation input 14:Presser foot alternation input.2 15:Needle lifting lock 16:Edge joint presser foot control input 17: Double needle machine left input; 18: Double needle machine right input; 19: Deputy tension control input			Output Definition
260	1	No. 1 electromagnet output definition		
261	3	No. 2 electromagnet output definition		
262	4	No. 3 electromagnet output definition		
263	5	No. 4 electromagnet output definition		
264	2	No. 5 electromagnet output definition		
265	6	No. 6 electromagnet output definition		
260	0:Output disable 1:Trimming 2:Thread wiping 3:Back stitch 4:Foot lifting 5:Thread slack 6:Thread nipping 7:Air sucking 8:Air blowing 9:Needle cooling 10: Presser foot alternation lifting 11: Air-tight joint 12:Back tacking reverse hanging mode 13:Alternation lifting mode 14:Air-tight joint mode 15:OP output 16:Bottom thread counter full condition 17:Trimming short thread head output 18: Edge joint presser foot control output 19: Double needle turn left needle bar actuation ; 20: Double needle turn right needle bar actuation ; 21: Double needle turn left state 22: Double needle turn right state 23: Deputy tension control output; 24: Deputy tension control state			

270	1~500	50	No.1 electromagnet fully output time ms	No.1 Electromagnet
271	1~100	1	No.1 electromagnet chopping on time ms(Reserved)	
272	1~100	1	No.1 electromagnet chopping off time ms(Reserved)	
273	0~600	0	No.1 electromagnet protection time 100ms	
274	1~500	70	No.2 electromagnet fully output time ms	
275	1~100	1	No.2 electromagnet chopping on time ms(Reserved)	
276	1~100	1	No.2 electromagnet chopping off time ms(Reserved)	
277	0~600	0	No.2 electromagnet protection time 100ms	
278	1~500	150	No.3 electromagnet fully output time ms	
279	1~100	1	No.3 electromagnet chopping on time ms(Reserved)	
27A	1~100	1	No.3 electromagnet chopping off time ms(Reserved)	
27b	0~600	0	No.3 electromagnet protection time 100ms	
27c	1~500	100	No.4 electromagnet fully output time ms	
27d	1~100	1	No.4 electromagnet chopping on time ms(Reserved)	
27E	1~100	1	No.4 electromagnet chopping off time ms(Reserved)	
27F	0~600	0	No.4 electromagnet protection time 100ms	
280	1~500	40	No.5 electromagnet fully output time ms	No.2 Electromagnet
281	1~100	0	No.5 electromagnet chopping on time ms(Reserved)	
282	1~100	0	No.5 electromagnet chopping off time ms(Reserved)	
283	0~600	0	No.5 electromagnet protection time 100ms	
284	1~500	100	No.6 electromagnet fully output time ms	
285	1~100	0	No.6 electromagnet chopping on time ms(Reserved)	
286	1~100	0	No.6 electromagnet chopping off time ms(Reserved)	
287	0~600	0	No.6 electromagnet protection time 100ms	

### 3.3 Monitoring Mode

- 1, **P** key and **⊗** key press can enter the monitor mode, LCD shown is **0240000**;
- 2, press the corresponding to **+** key and **-** key to select parameter number, can be real-time monitoring of changes in the corresponding parameters;
- 3, finally press the **P** key, is to return to the normal sewing pattern

No.	Description	No.	Description
010	Count needle number	023	Initial angle
011	Count piece number	024	Mech. Angle
020	busbar voltage	025	Pedal voltage sampling value
021	Mashine speed	026	Head drive than the actual value
022	Phase currunt	027	Motor total running time (Hour)
030-037	Fault code	029	DSP software version number

### 3.4 Safety switch warning mode

Alarm code	Code meaning	solution
ALA-1	Refueling remind	Press the P key can temporarily cancel alarm. Please refueling
ALA-2	Count needle number alarm	Count needle number has reached the limit, you can press the P key to cancel the alarm and re count
ALA-3	Piece number alarm	Said piece number has reached the limit, you can press the P key to cancel the alarm and re count
ALA-4	Emergency stop	Then press the emergency stop button, can eliminate the emergency stop status
ALA-5	Lift needle locking	Then press the needle lifting locking button, can eliminate the needle lifting locking state
POFF	Power off to remind	Please wait for 30 seconds and then re open the power switch
ARNUP	Turn the switch alarm	Put the head, ensure the turning switch restoration

### 3.5 False alarm mode

If the system error or warning, please first check the following items:







- 1, to confirm the connection machine is connected properly;
- 2, confirm the control and head matches;
- 3, confirm restore factory is accurate.

error code	meaning	solution
Err-01	hardware overflow	Turn off the system power, restart after 30 seconds, if the controller still does not work, please replace it and inform the manufacturer.
Err-02	software overflow	
Err-03	system under-voltage	Disconnect the controller power and check if the input voltage is too low (lower than 176V). If yes, please restart the controller when the normal voltage is resumed. If the controller still does not work when the voltage is at normal level, please replace the controller and inform the manufacturer.
Err-04	over-voltage when the machine is off	Disconnect the controller power and check if the input voltage is too high (higher than 264V). If yes, please restart the controller when the normal voltage is resumed. If the controller still does not work when the voltage is at normal level, please replace the controller and inform the manufacturer.
Err-05	over-voltage in operation	
Err-06	solenoid circuit failure	Turn off the system power, check if the solenoid is connected correctly and if it is loose or damaged. If yes, replace it in time. Restart the system upon making sure everything is in good order. If it still does not work, seek technical support.
Err-07	electrical current checking circuit failure	Turn off the system power, restart after 30 seconds to see if it works well. If not, try several more times. If such failure happens frequently, seek technical support.
Err-08	locked motor roller	Disconnect the controller power, check if the motor input plug is off, loose or damaged, or if there is something twined on the machine head. After checking and correction, if the system still does not work, please replace the controller and inform the manufacturer.
Err-09	brake circuit failure	Turn off the system power, check if the white brake resistance plug on the power board is loose or dropped off, fasten it and restart the system. If it still does not work, please replace the controller and inform the manufacturer.
Err-10	HMI communication failure	Check if the connecting line between control panel and controller is off, loose or broken, restore it and restart the system. If it still does not work, please replace the controller and inform the manufacturer.
Err-11	machine head needle positioning failure	Check if the connection line between machine head synchronizer and controller is loose or not, restore it and restart the system. If it still does not work, please replace the controller and inform the manufacturer.
Err-12	motor original angle checking failure	Please try 2 to 3 more times after power down, if it still does not work, please replace the controller and inform the manufacturer.
Err-13	Motor HALL failure	Turn off the system power, check if the motor sensor plug is loose or dropped off, restore it and restart the system. If it still does not work, please replace the controller and inform the manufacturer.

Err-14	DSP Read/Write EEPROM failure	Turn off the system power, restart the system after 30 seconds, if it still does not work, please replace the controller and inform the manufacturer.
Err-15	Motor over-speed protection	
Err-16	Motor reversion	
Err-17	HMI Read/Write EEPROM failure	
Err-18	Motor overload	Add oil to the needle rod, and set the P22 parameter at 4000, resume the working time after the last oil adding; or you can press button P to close the alarm and continue to use.
Err-19	Lack of oil alarm	

## 4 Special function operating instructions

### 4.1 Upper stop position adjust

1		<p>The control system in the recovery after the factory, according to the need to re set the needle position!</p> <p>The first step: first press  key, then press  key, enter into monitor mode. The default is 024, monitoring parameters, LCD screen displays the current point of view, such as 0° shows that this position is the system default on the needle stop position.</p>
2		<p>The second step: turn the hand wheel, let the thread take-up lever to the needle stop position or hope appropriate position adjusting to, the liquid crystal display screen adjustment of needle position, such as 124°</p>
3		<p>The third step: first press  key, then press  key, make the mechanical deflection angle is zero, on needle position set. Finally, according to the key to exit.</p>

### 4.2 A key recovery machine manufacturers parameter value

1		<p>If you want to restore the factory parameters, according to the following steps:</p> <p>The first step: first press  key, then press  key, enter into monitor mode; The default is 024, monitoring parameters.</p>
2		<p>The second step: long press  key for more than 3 seconds, start a key recovery machine factory parameters, LCD screen display bar, that is the restore parameters, the controller is not power or unplug the plug operation panel.</p>
3		<p>The digital tube display is 8 all, the nose factory parameters restore completed.</p>

### 4.3 Pedal sensitivity adjustment

Pedal movement by the initial position of the (parameter 136) began, slowly forward step to the (parameter 137) began to low-speed sewing, before continuing on to the (parameter 138) began to accelerate, and then on to the deep (parameter 139) reach maximum speed. In the period of maintenance of sewing speed, stepless speed regulation process between the segment;

- 1、n the pedal from the initial position to the (parameter 136) began to slow, after stepping on to the (parameter 135) when the presser foot lift automatically;
  - 2、hen the pedal from the initial position to the (parameter 136) began to slow, after stepping on to (parameter 134) automatically complete shear line.
- A value of

- 3、 the parameter settings are required to ensure that (parameter 134) < (parameter 135) < (parameter 136) < (parameter 137) < (parameter 138) < (parameter 139)
- 4、 an be used as the parameter's value through the pedal real-time monitoring of 025 parameters at different positions of the monitoring mode sampling numerical. Adjusting the corresponding parameters, presser foot and step on or after step action position change. As on the great distance machine is not running, may be appropriate to reduce the 137 parameters (not less than to the location parameters in 136), can improve the sensitivity of feet; if the machine is too sensitive, touch the pedal machines began to work, it may be appropriate to increase the 137 parameters; if it is not easy to fill needle, a little feet, speed quickly improve the cause forward multi needle, may be appropriate to increase or decrease the 138 parameters of 137 parameters (i.e. adding feet pedal speed range), can also be appropriate to reduce the initial seam speed (100).

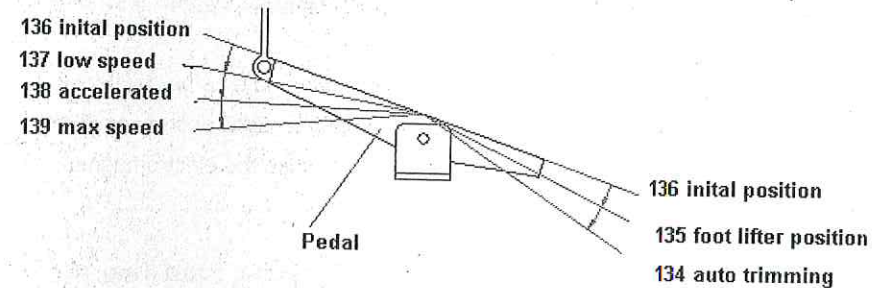

Fig. 4-1 pedal movement of each position parameter

### 4.4 Electromagnet performance adjustment

According to the typical configuration, parameters of 260 to 1, showed that the No. 1 electromagnets are set to cut the line electromagnet, the No. 1 electromagnet set parameter 270~273 is cutting line electromagnet set parameters. Parameters of 261 to 3, showed that the No. 2 electromagnet is set to reverse stitching electromagnet,

the No. 2 electromagnet set parameter 274~277 is reverse stitching electromagnet set parameters. Parameters of 262 to 4, showed that the No. 3 electromagnets are set to the presser foot lifting electromagnet, the electromagnet is No. 3 set parameter 278~27B is the presser foot lifting electromagnet set parameters.

· electromagnetic speed adjustment

If the solenoid pull slow, inadequate. Can increase the electromagnet full output time, such as increase of parameter 270, which increases the shear line electromagnet full output time, so as to improve the shear line pull speed, increased shear line. If the electromagnet voice is too large, may be appropriate to reduce the output time.



· electromagnet easiness

Can reduce the duty ratio, the appropriate chopper opening time parameters (such as 271) or reduce the closing time parameters (such as 272) increased (Note: if the opening time of the solenoid pull state may lead to inadequate or even ahead of the release ratio adjustment is too small,).

· the solenoid pull weakness, how to adjust the operating state dynamics (how to increase the pull strength when state



Can increase the duty ratio, the appropriate chopper opening time parameters (such as 275) increased, or the closing time parameters (such as 276) decreases (Note: if the opening time ratio adjustment is too large, easy to make the electromagnet heating)



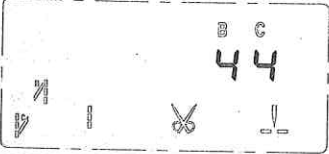
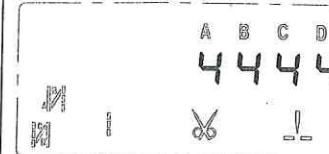
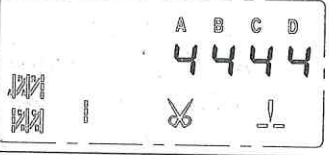
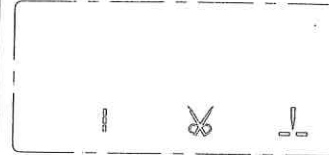
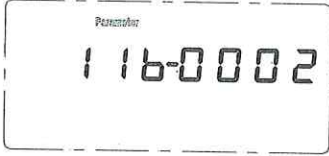



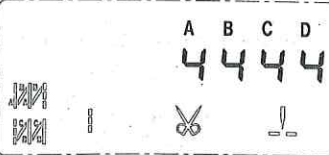

#### 4.5 Start/ end back tacking sewing mode set

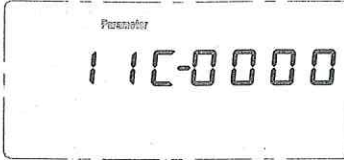
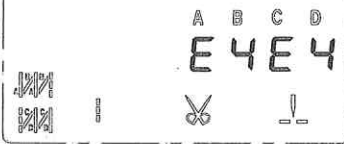
According to the fixed seam pattern, through the start back tacking sewing  key and end back tacking sewing  key, the system default support ①the single back tacking sewing , ②double back tacking sewing ③four back tacking sewing④ none back tacking sewing between the four modes to switch

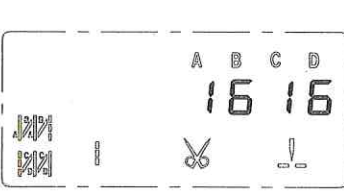
<p>① single start/end back tacking sewing mode set</p> 	<p>② double start/end back tacking sewing mode set</p> 
<p>③ four start/end back tacking sewing mode set</p> 	<p>④ None start/end back tacking sewing mode set</p> 
<div style="display: flex; justify-content: space-between;"> <div style="width: 45%;">  </div> <div style="width: 50%;"> <p>By adjusting the 11B parameters, modified back tacking sewing mode. If set to 1, only in the single fixed seam and closed seam sealing switch; if set to 2, then in the single fixed seam, double seam sealing and closing fixed seam switch; if set to 3, the double seam sealing and closing fixed seam switch; if set to 4, then in the double fixed seam, four fixed seam and close the gap between switching. Before and after the stitch seam sealing mode is specified by the 11B parameter.</p> </div> </div>	

#### 4.6 Start/ end back tacking sewing and Four-segment sewing is set long needle







<p>1</p> 	<p>When it is set start/end back tacking sewing of A/B/C/D and four segment sewing E/F/G/H , Select the corresponding  key and the  key can set the segment value addition and subtraction, the system default range is 1-F corresponds to the 1-15 pin.</p>
--	--



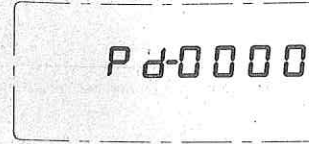



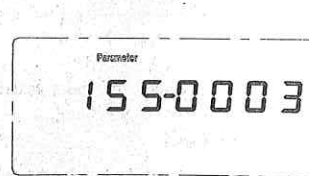

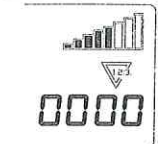

2		<p>But if you need to set the number of needles more, can be specified to set the number of needles by modifying 11C parameters and 11D parameters of ten, plus A/B/C/D and E/F/G/H segment is a digit, together constitute the total needle number. For example, in the setting of before and after the solid needle number, the default 11C parameters 0000</p>
3		<p>If A, C segment set is E, B segment, D segment set is 4, A, C segment the actual needle is 14, B, D segment the actual needle is 4.</p>
4		<p>The number of needle if any segment of the need to set more than 15 needles, then adjust the 11C parameters. If the 11C parameter is adjusted to 2121</p>
5		<p>At the same time, the corresponding A/B/C/D segment is set to 1/6/1/6, then A segment, C segment the actual needle number 21 needle, B segment, D segment actual pin number for 16 needle. Thus, the actual number of each needle the adjustable range can be extended to 1-99 needle.</p>
6		<p>Set before and after the four joint E/F/G/H segments fixed seam is similar, but the ten tuning parameters for 11D parameters. Note: the shortcut keys out of 11C parameters for press  and  key; shortcut key 11D parameters for press  and  key.</p>

### 4.7 H-70 operating panel count needle number / piece number function

H-70 operating panel contains special count needle number / piece number display module.

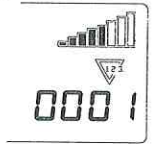
H-70 operating panel system parameter is set the way and the H-43 panel is the same

1		<p>The first step, press  key, then press  key, the LCD screen will be prompted to enter the password technician parameters, then press  key to enter the technician mode;</p>
2		<p>The second step, select the desired count needle number mode, usually can be set to 3, including the number of needle after press the reset key to cancel the alarm to count;</p>
3		<p>The third step, select the required piece number mode, transferred to the 155 parameters, can be set to 3, including the number of needle after press the reset key to cancel the alarm to count; then press  key save and exit.</p>
4		<p>If the open count needle number function or piece number function, operation panel will correspond to display count needle number marking or piece number marking. When the count needle number and piece number function are open in the all, the default display count needle number.</p>

5		<p>At this time , press  counting key can switch count needle number and piece function in the show .</p>
6		<p>The system default settings count fast modifying function. Adjustable parameter 158, modified to 1 to disable this feature, the default is 0 open this function.</p>
7		<p>At this time, display the count needle number, according to the counting key area, press   keys, the count needle number of the set value addition and subtraction.</p>
8		<p>Display piece number, according to the counting key area, press   keys, the piece number of the current value addition and subtraction.</p>
9		<p>Press the reset  key of count, the count value can be cleared for the currently displayed.</p>

386P0150A

2014-4-14